

# Bell 206B3

5-Place • Turbine Powered • Light Utility/Corporate Helicopter

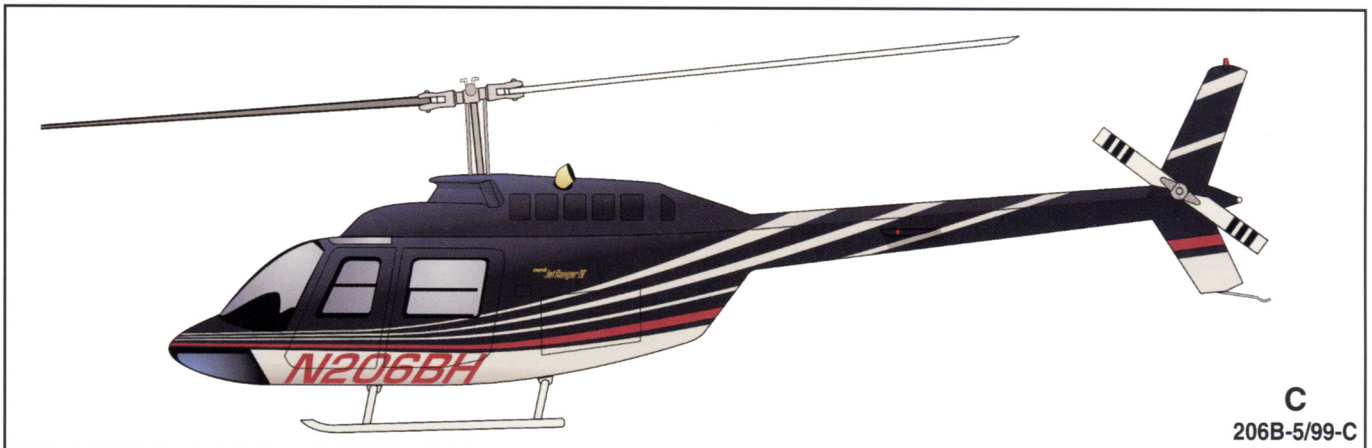
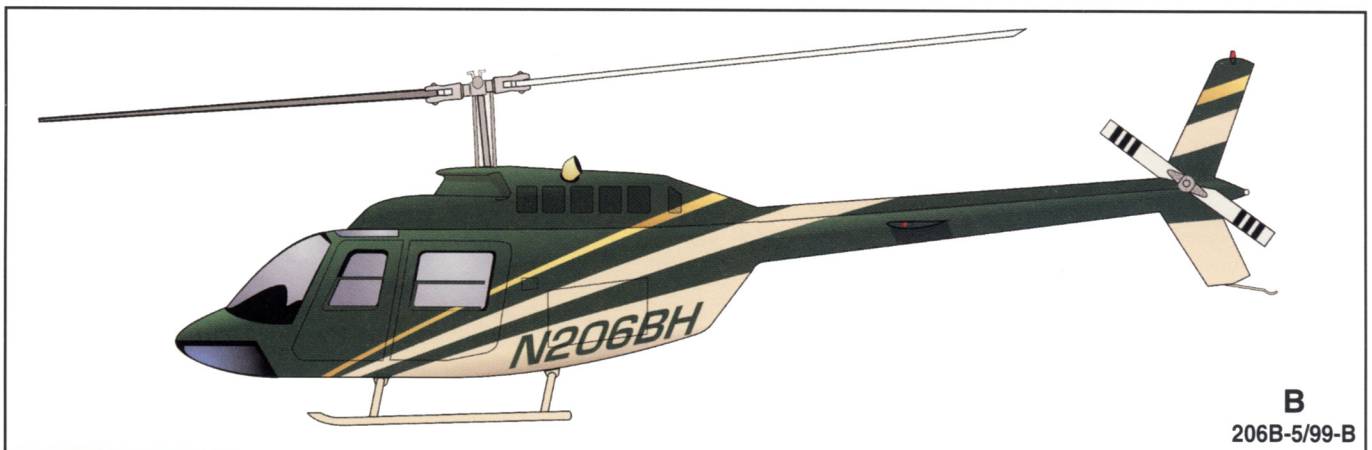
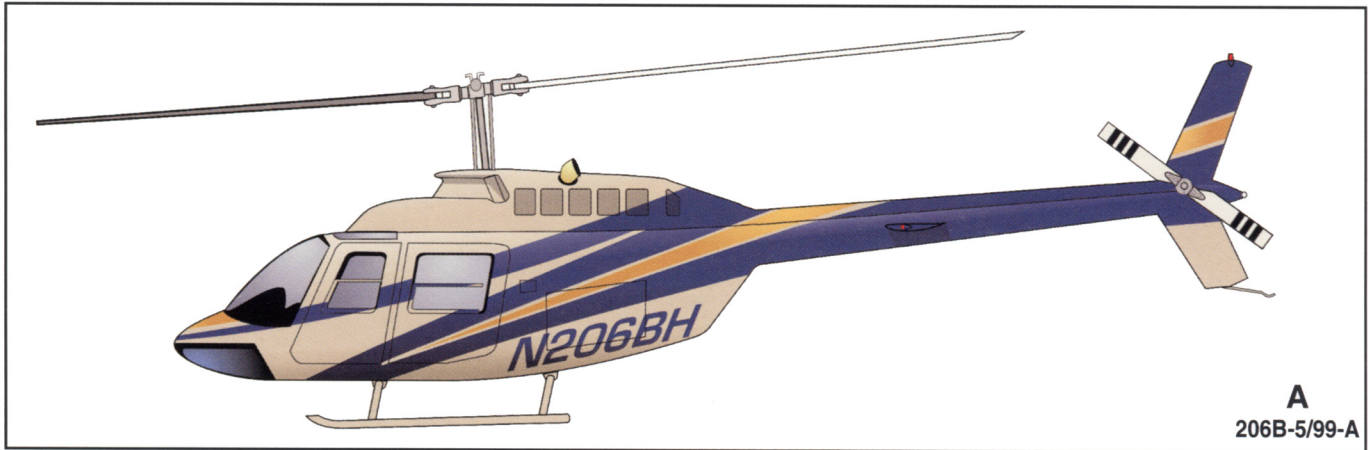

PRODUCT SPECIFICATIONS  
JANUARY 2004

**Bell** Helicopter  
A Textron Company

## **PUBLISHERS NOTICE**

The data presented in this document is general in nature, and has been compiled from Bell Helicopter Textron, Inc. [BHTI] source materials including but not limited to; The Approved Rotorcraft Flight Manual, Maintenance Manual, Illustrated Parts Catalog, and other engineering design specifications.

This document is intended for the use of **BHTI Sales Personnel** and for **prospective customers** as an aid in determining estimated weight and performance of the helicopter when configured with equipment for specific missions.

Disclosure, reproduction, or use of any material in this document by persons other than BHTI employees, and BHTI independent representatives [International Dealers] is **forbidden** without written permission from Bell Helicopter Textron.

The Part Numbers of Optional Equipment [KITS] are subject to revision and change, and also may be different for specific serial number helicopters or special custom configurations. Please consult the *NOTES* found in the right margins of the optional equipment list pages for **equipment compatibility**. The continuing product improvement process of BHTI may cause some components, equipment, and compatibility to be changed or replaced.

The SPECIFICATIONS, WEIGHTS, DIMENSIONS, AND PERFORMANCE DATA shown in this document is subject to change without notice.



## DIMENSIONS

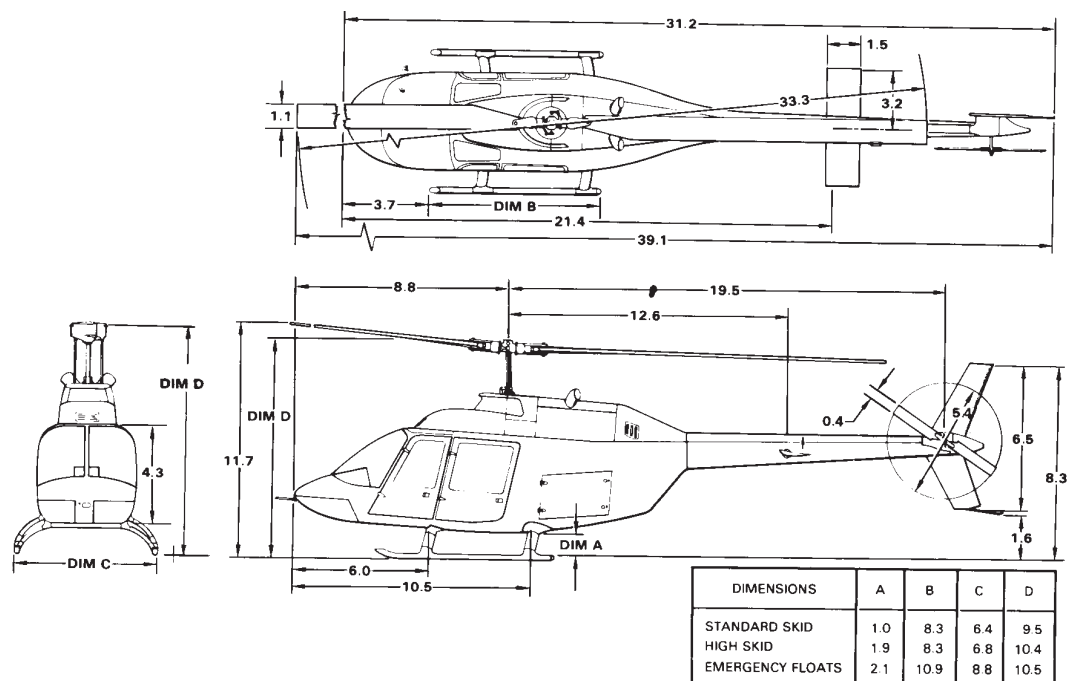

**THREE COLOR DUPONT POLYURETHANE FINISH APPLIED PER BHT PAINT SCHEMES INCLUDED IN LIST PRICE. SPECIAL PAINT SCHEMES QUOTED ON REQUEST.**

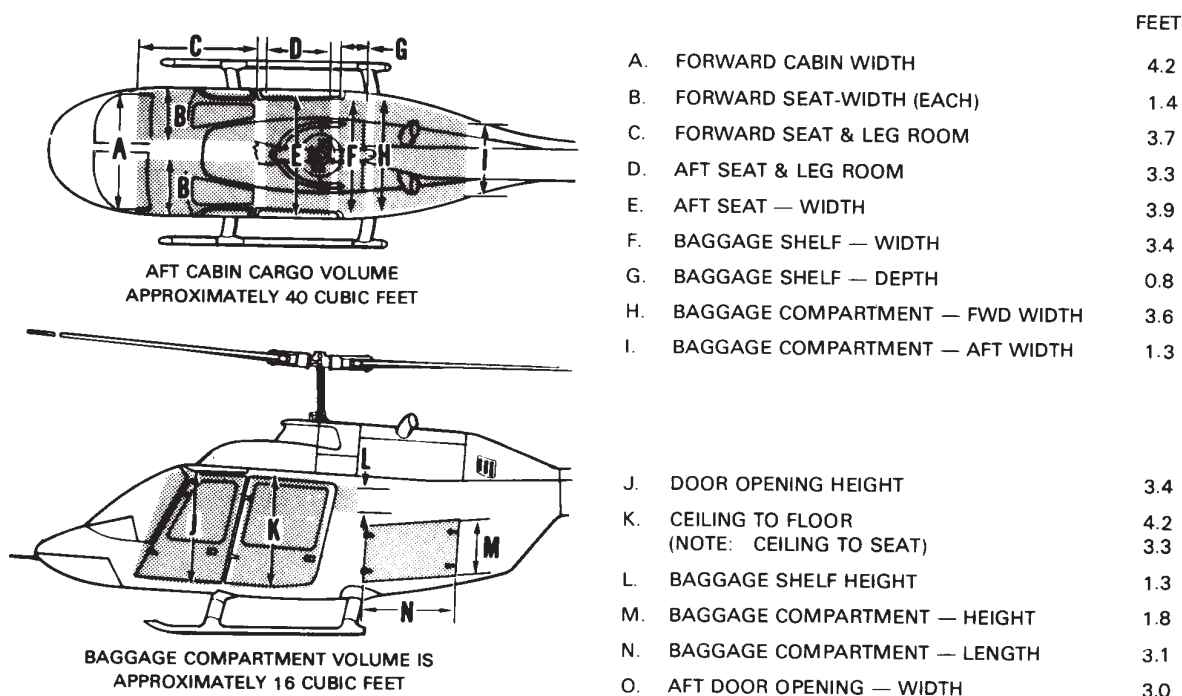

Specifications subject to change without notice.



## SPECIFICATION SUMMARY[U. S. Units]

[Serial No. 4576 & Subsequent]

<u>WEIGHTS</u>	<u>LBS</u>
Standard Configuration Weight ( <b>Note 1</b> )	1710
Internal Gross Weight	3200
External Load Gross Weight	3350
Standard Configuration Useful Load (Gross Weight-Standard Configuration)	1490
Maximum External Load (Cargo Hook Limit)	1500

**Note 1:** Includes twelve (12.0) pounds of engine oil. **Ballast** is not included in standard configuration weight (ballast is a function of installed equipment).

### PERFORMANCE SUMMARY: (International Standard Day Except as Noted)

••• REFER TO DEMONSTRATED TAKEOFF & LANDING AND MAXIMUM OPERATING ALTITUDE NOTES ON THE PERFORMANCE CHARTS •••

<u>TAKEOFF GROSS WEIGHT</u>		<u>LBS</u>	<u>2600</u>	<u>3000</u>	<u>3200</u>
IGE Hovering Ceiling (2 ft skid height)	ISA	ft	19,600	15,200	13,200
	ISA+20C	ft	16,800	12,300	10,200
OGE Hovering Ceiling	ISA	ft	14,900	10,300	5300
	ISA+20C	ft	11,800	7200	3000
Certificated Altitude	ISA	ft	20,000	20,000	13,500
Service Ceiling (MCP) (100 ft/min)	ISA	ft	20,000+	18,200	13,500
Sea Level Max R/C (TOP)	ISA	ft/min	2080	1540	1280
Maximum Allowable IAS	ISA, SL	kn	130	130	122
	ISA, 5000ft	kn	124	124	108
MCP Speed @ Takeoff GW	ISA, SL	kn	121	118	115
	ISA, 5000ft	kn	128	122	115
Range @ LRC speed (Avg. GW, Full Fuel)	ISA, SL	nm	389	382	374
	ISA, 5000ft	nm	435	412	395
Endurance @ Loiter 52 kn (No Reserve)	ISA, SL	hr			4.5

### ENGINE POWER RATINGS:

( **STANDARD** Rolls-Royce 250-C20J ) Uninstalled Mechanical Rating

Takeoff , SHP	420
Maximum Continuous, SHP	370

### TRANSMISSION RATINGS:

Takeoff , SHP	317
Maximum Continuous, SHP	270

### FUEL:

Type	Aviation Turbine
Capacity (Usable)	91 Gallons

THE DATA SET FORTH ON THIS DOCUMENT ARE GENERAL IN NATURE AND MAY VARY WITH CONDITIONS. FOR PERFORMANCE DATA AND OPERATING LIMITATIONS FOR ANY SPECIFIC FLIGHT MISSION, REFERENCE MUST BE MADE TO THE APPROVED FLIGHT MANUAL.



## SPECIFICATION SUMMARY [Metric Units]

[Serial No. 4576 & Subsequent]

### WEIGHTS

	<b>KG</b>
Standard Configuration Weight ( <b>Note 1</b> )	776
Internal Gross Weight	1451
External Load Gross Weight	1519
Standard Configuration Useful Load (Gross Weight-Standard Configuration)	675
Maximum External Load (Cargo Hook Limit)	680

**Note 1:** Includes 5.4 kilograms of engine oil. **Ballast** is not included in standard configuration weight (ballast is a function of installed equipment).

### PERFORMANCE SUMMARY: (International Standard Day Except as Noted)

••• REFER TO DEMONSTRATED TAKEOFF & LANDING AND MAXIMUM OPERATING ALTITUDE NOTES ON THE PERFORMANCE CHARTS •••

<u>TAKEOFF GROSS WEIGHT</u>		<u>KG</u>	<u>1179</u>	<u>1361</u>	<u>1451</u>
IGE Hovering Ceiling (0.6 M skid height)	ISA	M	5974	4633	4023
	ISA+20C	M	5121	3749	3109
OGE Hovering Ceiling	ISA	M	4542	3139	1615
	ISA+20C	M	3597	2195	914
Certificated Altitude	ISA	M	6096	6096	4115
Service Ceiling (MCP) (0.5 M/S)	ISA	M	6096+	5547	4115
	ISA	M/S	10.6	7.8	6.5
Sea Level Max R/C (TOP)	ISA	M/S	10.6	7.8	6.5
	ISA, SL	km/h	241	241	226
Maximum Allowable IAS	ISA, 1524M	km/h	230	230	200
	ISA, SL	km/h	224	219	213
MCP Speed @ Takeoff GW	ISA, SL	km/h	224	219	213
	ISA, 1524M	km/h	237	226	213
Range @ LRC Speed (Avg. GW, Full Fuel)	ISA, SL	km	721	708	693
	ISA, 1524M	km	806	764	732
Endurance, @ Loiter 96 km/h (No Reserve)	ISA, SL	hr			4.5
	ISA, SL	hr			4.5

### ENGINE POWER RATINGS:

( **STANDARD** Rolls-Royce 250-C20J ) Uninstalled Mechanical Rating

Takeoff , kW	313
Maximum Continuous, kW	276

### TRANSMISSION RATINGS:

Takeoff , kW	236
Maximum Continuous, kW	201

### FUEL:

Type	Aviation Turbine
Capacity (Usable)	344 Liters

THE DATA SET FORTH ON THIS DOCUMENT ARE GENERAL IN NATURE AND MAY VARY WITH CONDITIONS. FOR PERFORMANCE DATA AND OPERATING LIMITATIONS FOR ANY SPECIFIC FLIGHT MISSION, REFERENCE MUST BE MADE TO THE APPROVED FLIGHT MANUAL.



## JETRANGER III SEATING

**CREW SEATING** - Two individual ergonomically designed seats with adjustable lumbar support, each equipped with seat belt, double strap shoulder harness and inertia reel, are located in the cockpit. The color and upholstery material for the seats, and interior trim of the cockpit match that which is selected for the cabin.

## STANDARD INTERIOR

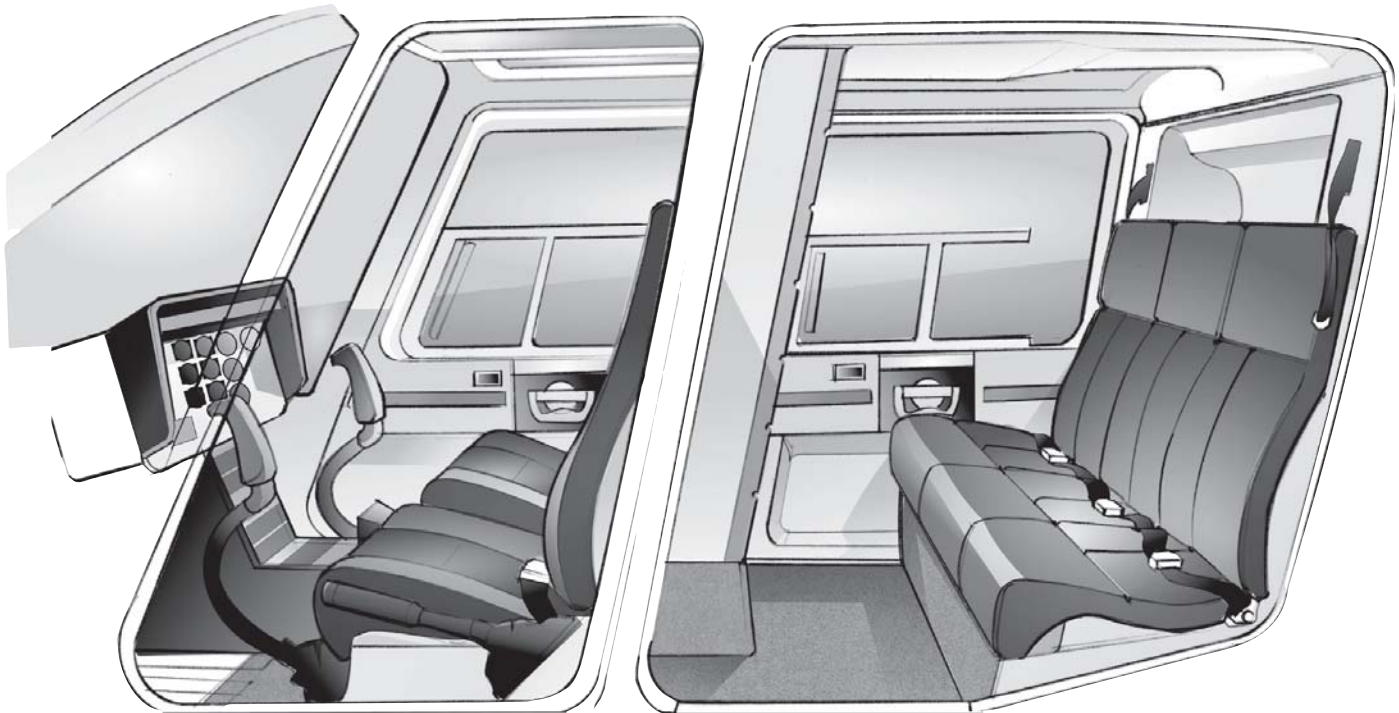

**STANDARD SEATING & INTERIOR TRIM** - The **standard** cabin seating consists of **three equal width** seats with individual seat belts and single strap shoulder harness, arranged across the rear of the cabin. Available with Red, Blue, Tan, or Gray **fabric** upholstery with Black seat belts. All vinyl upholstery, or vinyl with fabric inserts are available as an **extra cost** option. The **standard interior trim** consists of plastic closeouts on sidewalls/window reveals, hat box, fuel cell and control column. The floor is covered in low loop lightweight blend carpet. The standard seating and interior trim are included in the basic aircraft weight.

Specifications subject to change without notice.



## **CORPORATE INTERIOR**

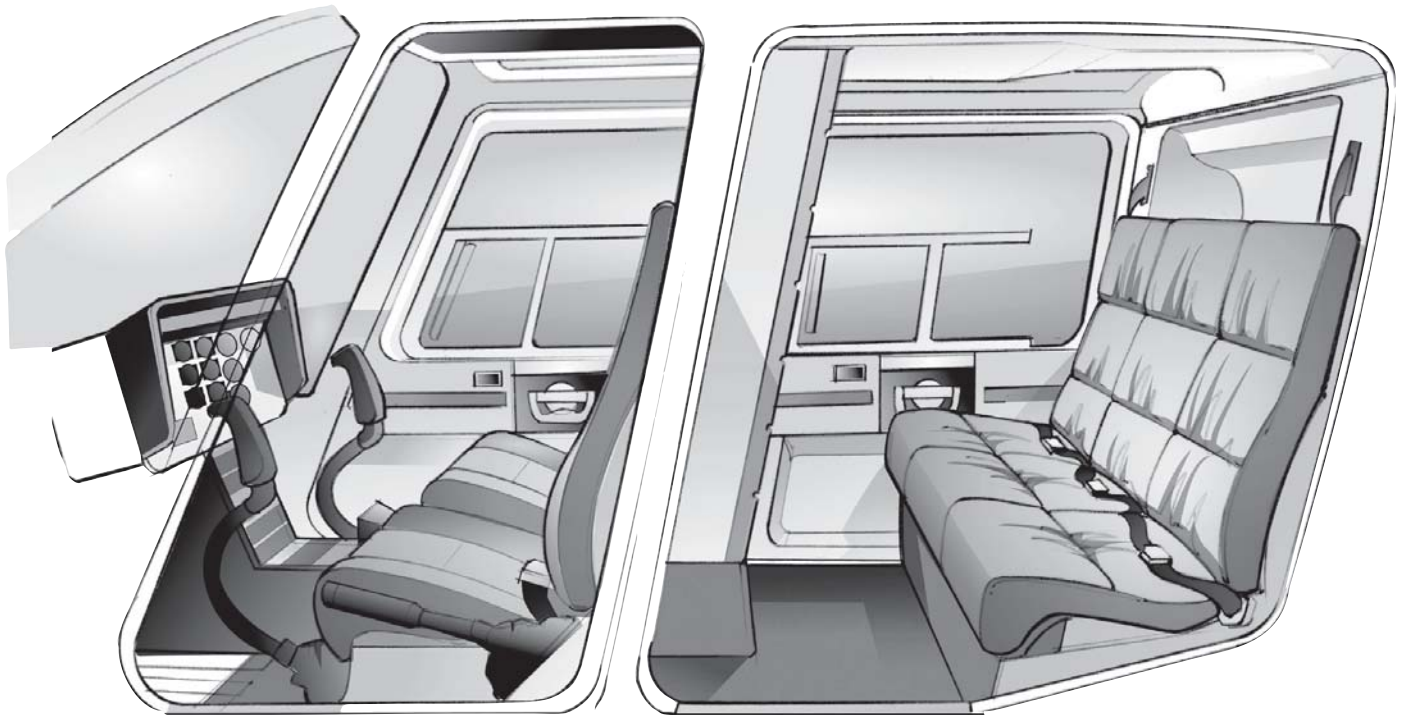

*CORPORATE SEATING & INTERIOR TRIM - The corporate cabin seating consists of **three equal width** seats with individual seat belts and single strap shoulder harness, arranged across the rear of the cabin. Available with Pewter, Mushroom, Dark Blue, Saddle, Burgundy, Smoke Grey, and Forest Green upholstery with Black seat belts. Seats can be all fabric (basic corporate seats), or optional leather with fabric inserts, or all leather with perforated leather inserts. Carpet is 100% wool cut pile.*

*Specifications subject to change without notice.*



## **STANDARD CONFIGURATION** ***(Items Included In List Price)***

### **AIRFRAME**

Cabin; bonded aluminum honeycomb, and semi-monocoque structure  
Engine mount struts with noise dampers  
Doors, four, hinged forward, dual point latching  
Landing gear, tubular skid type with replaceable skid shoes  
Locks for cabin doors and luggage compartment  
Luggage compartment (16 ft<sup>3</sup> [.45 M<sup>3</sup>], 250 lbs [113 Kg]cap), with Composite Door  
Provisions for mooring, jacking and single point lifting  
Tail boom, monocoque structure with vertical fin and fixed elevator  
Tail skid (tail rotor guard)  
Windshield (and Chin Windows), clear plexiglass  
Windows, blue tinted plexiglass with sliding panels in doors, Passenger Cabin "Wedge" Windows  
Three color exterior paint scheme  
Rain gutters

### **INTERIOR**

Standard 5-place interior with soundproofing, carpeting, & data case. Color options available for upholstery & carpet  
5-place shoulder harnesses, dual straps in cockpit, single strap in cabin  
Fire extinguisher, cabin  
First aid kit  
Parcel shelf (behind aft seat)  
Ram air ventilation system

### **POWERPLANT**

Rolls-Royce Model **250-C20J** gas turboshaft engine  
Wet spline starter-generator  
Fuel boost pumps (2 canister type) submerged in fuel tanks  
Fuel control, Bendix  
Fuel filter (eliminates PRIST requirements)  
Fuel system, 91 gal. (344 liter) capacity

Oil system, 1.5 gal [5.7 liter] capacity  
Compressor wash provisions

### **ROTORS & CONTROLS**

Main rotor, semi-rigid, two-bladed, see-saw type with precone and underslung feathering axis. All metal blades that are moisture proofed and epoxy encapsulated. Flap restraints. **CHOICE** of **STANDARD** [black top-white bottom] or **HIGH VISIBILITY** [orange/white top-white bottom] painted rotor blades  
Tail rotor; semi-rigid, two-bladed, see-saw type  
Hydraulic boost system (pump and reservoir module)  
Mechanical flight control linkages throughout

### **TRANSMISSION DRIVE SYSTEM**

Focused pylon mounting  
Freewheeling unit (between engine and main transmission)  
Gearbox, tail rotor with 2.3:1 spiral bevel gear reduction  
Hydraulic pump (for boost controls)  
Main transmission 2 stage 15.22:1 planetary reduction  
Oil cooler  
Oil filter with replaceable type cartridge  
Oil pump, constant pressure

### **FLIGHT & ENGINE INSTRUMENTS**

Clock, digital quartz chronometer  
Compass, magnetic  
Dual tachometer (rotor and engine)  
Inclinometer  
Indicator, airspeed  
Indicator, altimeter  
Indicator, engine oil pressure/temperature  
Indicator, free air temperature  
Indicator, fuel quantity  
Indicator, fuel pressure/generator load  
Indicator, gas producer speed  
Indicator, torquemeter pressure

*Specifications subject to change without notice.*



## **STANDARD CONFIGURATION (continued)** **(Items Included In List Price)**

### **FLIGHT & ENGINE INSTRUMENTS (cont.)**

Indicator, transmission oil pressure/  
temperature  
Indicator, turbine outlet temperature  
with over temp light  
Hour meter

### **MONITORING SYSTEM**

Caution indication lights  
Baggage door open  
Engine fuel pump inoperative  
Engine failure warning  
Fuel filter by-pass indicator  
Generator failure  
Transmission oil pressure  
Transmission oil temperature  
Chip detectors, magnetic--engine,  
main transmission, tail rotor gearbox  
Engine out and low rotor RPM warning  
lights and horn with mute switch  
Battery temperature sensor  
Battery hot  
Freewheeling unit/magnetic plug  
Fuel Low Warning

### **ELECTRICAL**

28 volt DC system  
Battery, 17 amp-hr nickel-cadmium  
External power and grounding  
receptacles  
Lights:  
Anti-collision strobe  
Cockpit/map  
Instrument  
Landing (two 250 watt)  
Position  
Starter-generator (150 ampere)  
Voltage regulator, Solid State  
28 volt outlet in cabin  
Heated pitot tube

### **MISCELLANEOUS**

Covers, turbine inlet and exhaust pipes  
Cover pitot tube  
Flight bag  
Grounding handling wheels w/lift tube  
Operating manuals;  
Aircraft log book  
Engine log book  
Engine operating manual  
Engine parts manual  
Flight manual  
Illustrated parts catalog  
Maintenance & overhaul manual  
Tie-down assemblies, main rotor and  
tail rotor

*Specifications subject to change without notice.*



## OPTIONAL ACCESSORIES

••••• REFER TO NOTES FOR KIT COMPATIBILITY •••••

Part Number	Kit Description	Wt (lbs)	Wt (Kg)	Notes
<b>AIRFRAME</b>				
206-706-031-109	HIGH SKID GEAR (INCL. AAI FLIGHT STEPS)	32.2	14.6	(1, 13)
206-706-127-111	DUAL CONTROLS	9.6	4.4	
206-706-211-109	LIGHT WEIGHT POP-OUT FLOATS	148.0	67.1	(1)
206-706-510-101	SKID GEAR FAIRINGS	10.3	4.7	(2)
<b>AVIONICS</b>				
206-705-008-103	VHF EQUIPMENT (KX-155)	7.7	3.5	
206-705-008-115	TRANSPONDER PROVISIONS (KT-76A)	1.0	0.5	(3)
206-705-008-117	TRANSPONDER EQUIPMENT (KT-76A)	2.5	1.1	(3)
206-705-008-131	ADF EQUIPMENT (KR-87)	7.1	3.2	
206-705-008-151	OMNI W/ PROVISIONS (KI208)	3.4	1.5	
206-705-008-155	TRANSPONDER PROVISIONS (DIGITAL) (KT-70)	1.0	0.5	(3)
206-705-008-157	TRANSPONDER EQUIPMENT (DIGITAL) (KT-70)	3.9	1.8	(3)
206-705-008-167	VHF/ADF PROVISIONS W/ AUDIO PANEL (KMA24H-71)	10.6	4.8	
206-706-007-101	ENCODING ALTIMETER	0.9	0.4	(1, 3)
206-706-051-101	BLIND ENCODING ALTIMETER	2.0	0.9	(3)
206-706-323-111	FLIGHT INSTRUMENTS [for less Dir. Gyro. See Note/Credits]	10.5	4.8	(4)
<b>ENGINE</b>				
206-706-038-105	AUTO RE-LIGHT FOR C-20J ENGINE	0.4	0.2	
206-706-038-107	AUTO RE-LIGHT ( STC SH4781NM ) FOR C-20R ENGINE	2.4	1.1	
206-706-200-107	PARTICLE SEPARATOR	6.9	3.1	(1)
<b>ENVIRONMENT</b>				
206-705-400-101	STANDARD HEADLINER w/ A/C DUCTS [for STC A/C]	11.0	5.0	(5)
<b>EQUIPMENT</b>				
206-706-034-107	ROTOR BRAKE	11.6	5.3	
206-706-126-105	RESCUE HOIST	35.1	15.9	
206-706-126-109	RESCUE HOIST PROVISIONS	11.8	5.4	
206-706-136-101	SNOW BAFFLE	0.8	0.4	(12)
206-706-214-103	HOIST CABLE GUARD	2.1	1.0	
206-706-314-103	LITTER PROVISIONS [Dual Litter System]	16.9	7.7	
206-706-324-103	LITTER EQUIPMENT [Two folding litters]	33.0	15.0	
206-706-330-101	AUXILIARY 13 AMP HOUR BATTERY (AFT)	6.0	2.7	(6)
206-706-335-101	CARGO HOOK EQUIPMENT	22.7	10.3	
206-706-335-107	CARGO HOOK PROVISIONS	4.1	1.9	
<b>INTERIOR</b>				
206-705-717-103	CORPORATE SEATS	0.0	0.0	(1, 11)
206-706-039-105	SOUND PROOFING	20.6	9.3	

Specifications subject to change without notice.



## OPTIONAL ACCESSORIES (continued)

\*\*\*\*\* REFER TO NOTES FOR KIT COMPATIBILITY \*\*\*\*\*

Part Number	Kit Description	Wt (lbs)	Wt (Kg)	Notes
<b>PAINT</b>				
HIGH VISIBILITY	MARKINGS FOR HIGH VIS. M/R BLADES (WHITE & ORANGE)	0.0	0.0	(7)
<b>STC's</b>				
<b>ENVIRONMENT</b>				
206-0102-1	AIR CONDITIONER EQUIPMENT [Air Com]	113.0	51.3	(5)
<b>EQUIPMENT</b>				
SX-16C/016551	NIGHTSUN SEARCHLIGHT	69.6	31.6	(8)
965-36502-002	WIRE STRIKE - RECOMMENDED KIT - SEE NOTE			(9)
	LOW SKIDS	16.4	7.4	
	HIGH SKIDS	17.4	7.9	
<b>PRODUCTION OPTION [NOT A KIT]</b>				
680-1000-5	C20/R4 ENGINE OPTION	26.0	11.8	(10)
<b>Credits</b>				
<b>AVIONICS</b>				
206-075-606-107	DIRECTIONAL GYRO	-3.6	-1.6	(4)
<b>EQUIPMENT</b>				
206-050-127-009/010	GROUND HANDLING WHEELS	27.0	12.2	
<b>PAINT</b>				
NO EXTERIOR	NO EXTERIOR PAINT	-14.8	-6.7	
WHITE	WHITE PAINT ONLY	0.0	0.0	

**All equipment kits require Provision Kits prior to installation**

**Notes: For commonality, notes shown below are identical in Product Specification and Price List.**

- 1) Price and/or weight includes credit for basic ship hardware.
- 2) Only compatible with low skid gear.
- 3) Encoding Altimeter or Blind Encoder required to enable Mode C or Mode S Altitude reporting. Customer is responsible for obtaining Aircraft ID code for Mode S.
- 4) Flight Instruments Less D. G. requires a Sales Order Amendment (Kit number is the SAME).
- 5) The Standard Headliner with A/C Ducts is required for installation of the STC Air Com airconditioner.
- 6) Provisions Only - The 13 amp hour battery weighs an additional 24.5 lbs (11.1 kg).
- 7) Standard or High Visibility Main Rotor Blade Paint to be specified by Sales Order.
- 8) Requires High Skids.
- 9) The Wire Strike Kit is a RECOMMENDED extra cost option. The customer must specify on the Purchase Agreement for the WSPS Kit NOT to be installed.
- 10) Includes STC Kit 174104-01 (Facet External Engine Oil Filter) 4.0 lbs (1.8 kg.).
- 11) Material type to be called out on Sales Order. Can be Leather, Fabric/Leather, or Fabric.
- 12) Particle Separator and Auto Relight Kits are required for installation of Snow Baffles.
- 13) "J Steps" (4 each) may be substituted for the AAI FlightSteps by Sales Order. Substitution of "J Steps" reduce High Skid Kit installed weight by 10.5 lbs (4.8 kg.).

**STC Kits** - Select Supplemental Type Certificated Optional Equipment Kits are available for installation at the Bell Helicopter Textron factory. Please contact your Bell Sales Representative for availability and pricing information.

**P.O.R.** - Priced On Request.



INTENTIONALLY LEFT BLANK



**HELICOPTER PERFORMANCE**  
**IGE & OGE HOVER, SERVICE CEILING**  
**FOR**  
**STANDARD ROLLS-ROYCE 250-C20J ENGINE**  
**&**  
**OPTIONAL ROLLS-ROYCE 250-C20R/4**  
**ENGINE**  
**BASIC INLET INSTALLED**  
**MINIMUM SPEC. ENGINE**



## STANDARD, ROLLS-ROYCE 250-C20 B/J ENGINE, BASIC INLET HOVERING CEILING IGE

GROSS WEIGHT – 100 KG

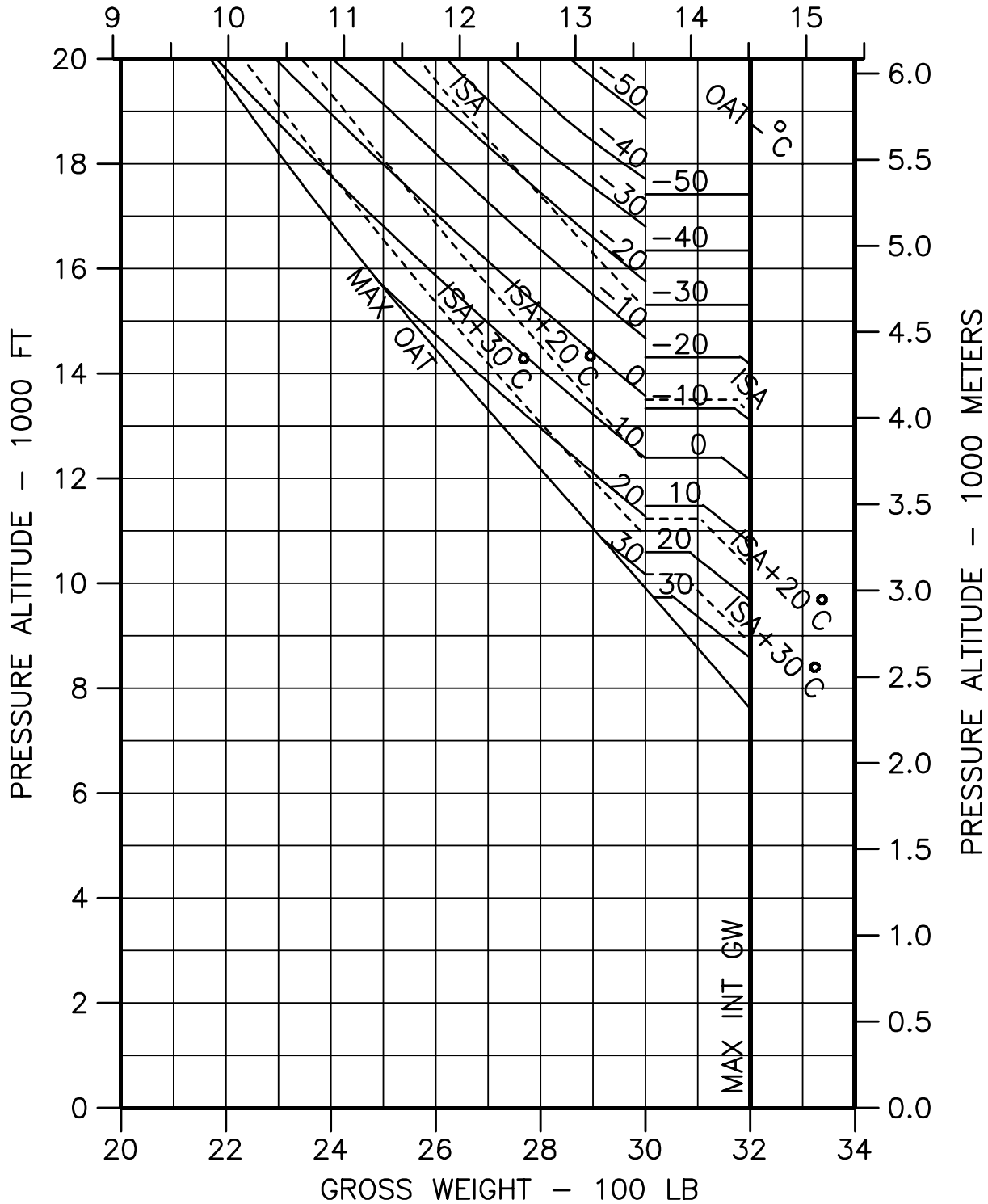

NOTE: TAKEOFF AND LANDING HAS NOT BEEN DEMONSTRATED AND IS NOT APPROVED ABOVE 16,000 FEET / 4877 METERS **DENSITY ALTITUDE**.

THE DATA SET FORTH ON THIS DOCUMENT ARE GENERAL IN NATURE AND MAY VARY WITH CONDITIONS. FOR PERFORMANCE DATA AND OPERATING LIMITATIONS FOR ANY SPECIFIC FLIGHT MISSION, REFERENCE MUST BE MADE TO THE APPROVED FLIGHT MANUAL.



## STANDARD, ROLLS-ROYCE 250-C20 B/J ENGINE, BASIC INLET HOVERING CEILING OGE

GROSS WEIGHT – 100 KG

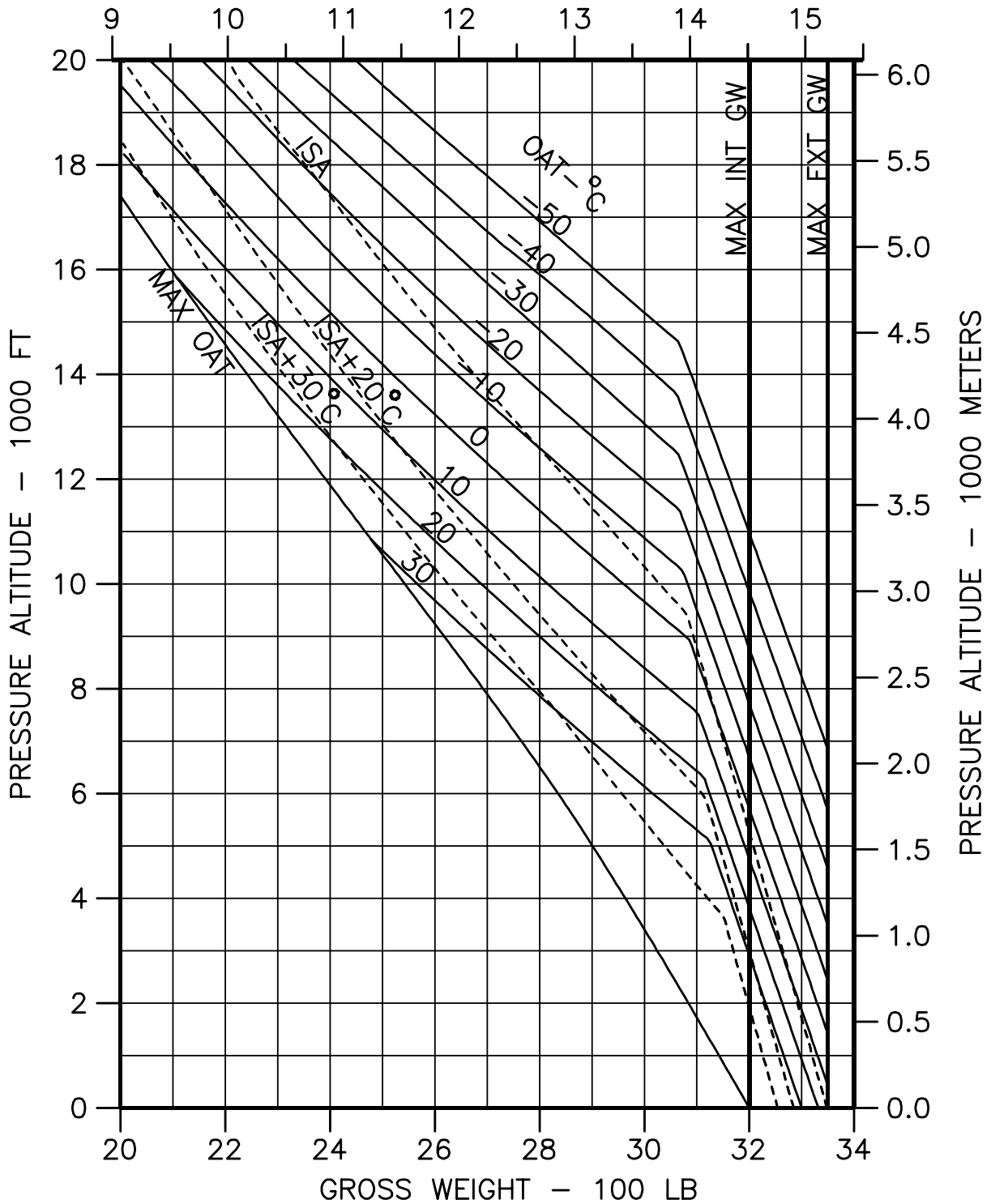

NOTE: TAKEOFF AND LANDING HAS NOT BEEN DEMONSTRATED AND IS NOT APPROVED ABOVE 16,000 FEET / 4877 METERS **DENSITY ALTITUDE**.

THE DATA SET FORTH ON THIS DOCUMENT ARE GENERAL IN NATURE AND MAY VARY WITH CONDITIONS. FOR PERFORMANCE DATA AND OPERATING LIMITATIONS FOR ANY SPECIFIC FLIGHT MISSION, REFERENCE MUST BE MADE TO THE APPROVED FLIGHT MANUAL.



## OPTIONAL, ROLLS-ROYCE 250-C20 R/4 ENGINE, BASIC INLET HOVERING CEILING IGE

GROSS WEIGHT – 100 KG

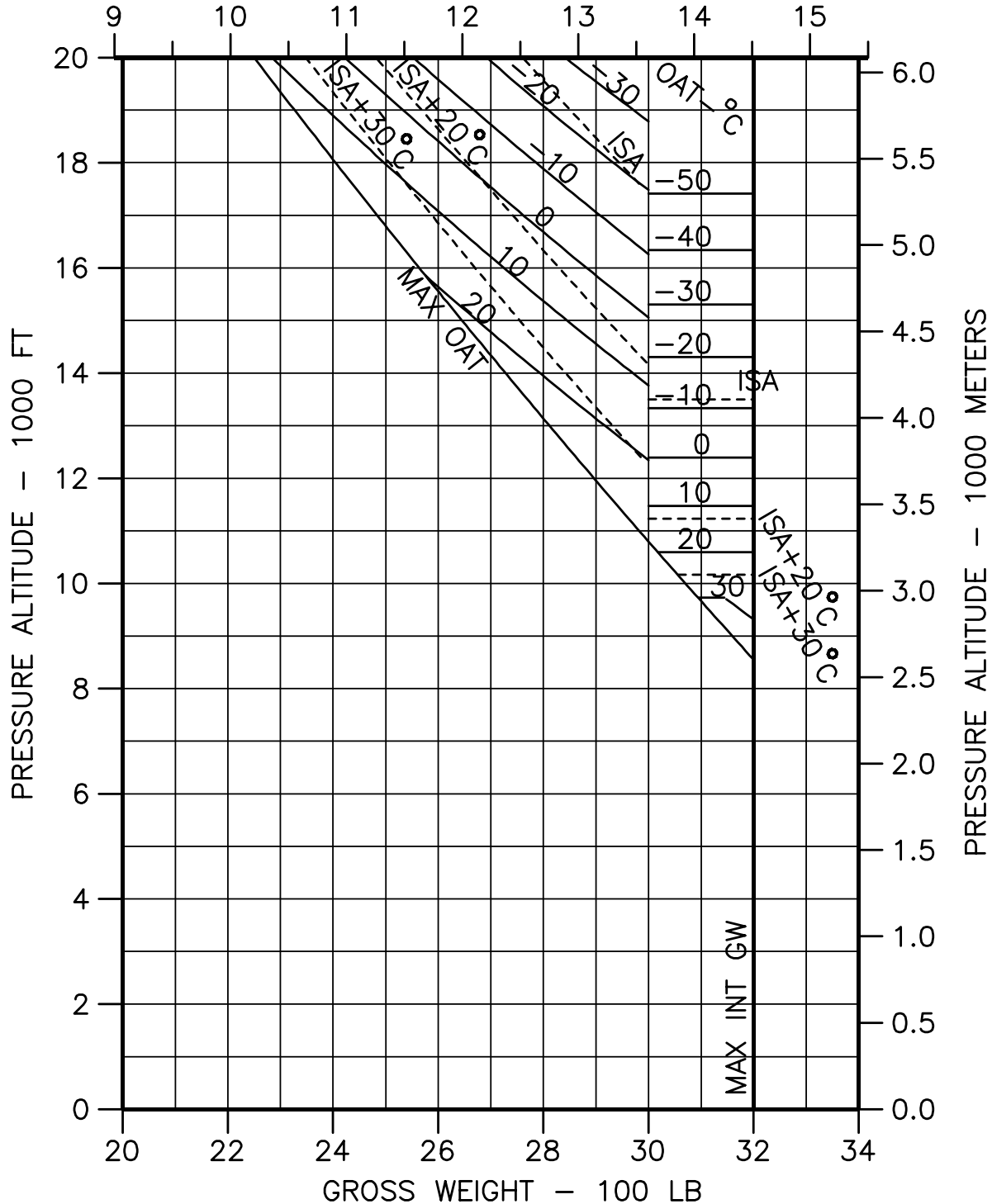

NOTE: TAKEOFF AND LANDING HAS NOT BEEN DEMONSTRATED AND IS NOT APPROVED ABOVE 16,000 FEET / 4877 METERS **DENSITY ALTITUDE**.

THE DATA SET FORTH ON THIS DOCUMENT ARE GENERAL IN NATURE AND MAY VARY WITH CONDITIONS. FOR PERFORMANCE DATA AND OPERATING LIMITATIONS FOR ANY SPECIFIC FLIGHT MISSION, REFERENCE MUST BE MADE TO THE APPROVED FLIGHT MANUAL.



## OPTIONAL, ROLLS-ROYCE 250-C20 R/4 ENGINE, BASIC INLET HOVERING CEILING OGE

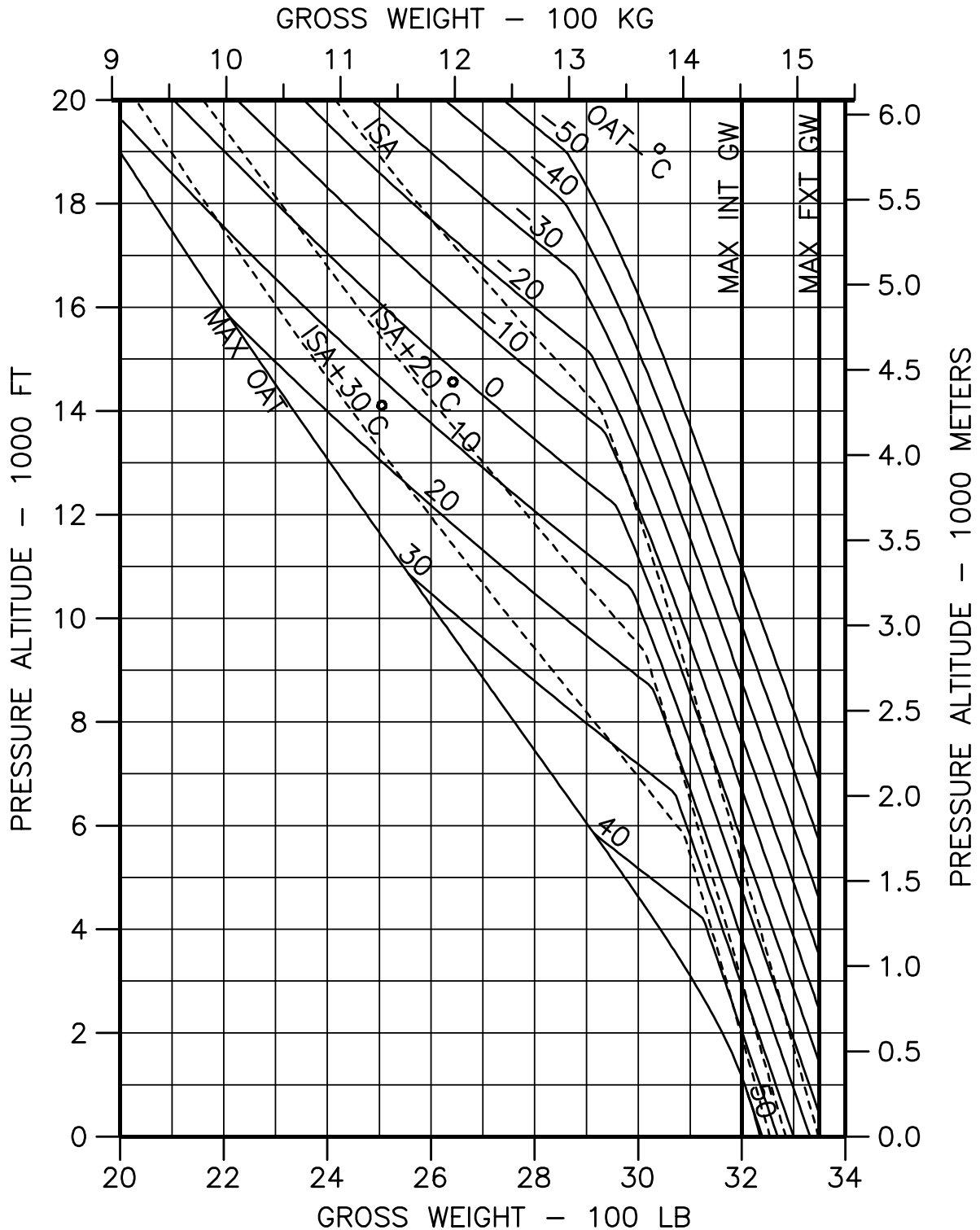

NOTE: TAKEOFF AND LANDING HAS NOT BEEN DEMONSTRATED AND IS NOT APPROVED ABOVE 16,000 FEET / 4877 METERS **DENSITY ALTITUDE**.

THE DATA SET FORTH ON THIS DOCUMENT ARE GENERAL IN NATURE AND MAY VARY WITH CONDITIONS. FOR PERFORMANCE DATA AND OPERATING LIMITATIONS FOR ANY SPECIFIC FLIGHT MISSION, REFERENCE MUST BE MADE TO THE APPROVED FLIGHT MANUAL.



## SERVICE CEILING

**STANDARD, ROLLS-ROYCE 250-C20 B/J ENGINE, BASIC INLET AT MCP  
100 FPM (0.5 M/S) RATE OF CLIMB**

GROSS WEIGHT – 100 KG

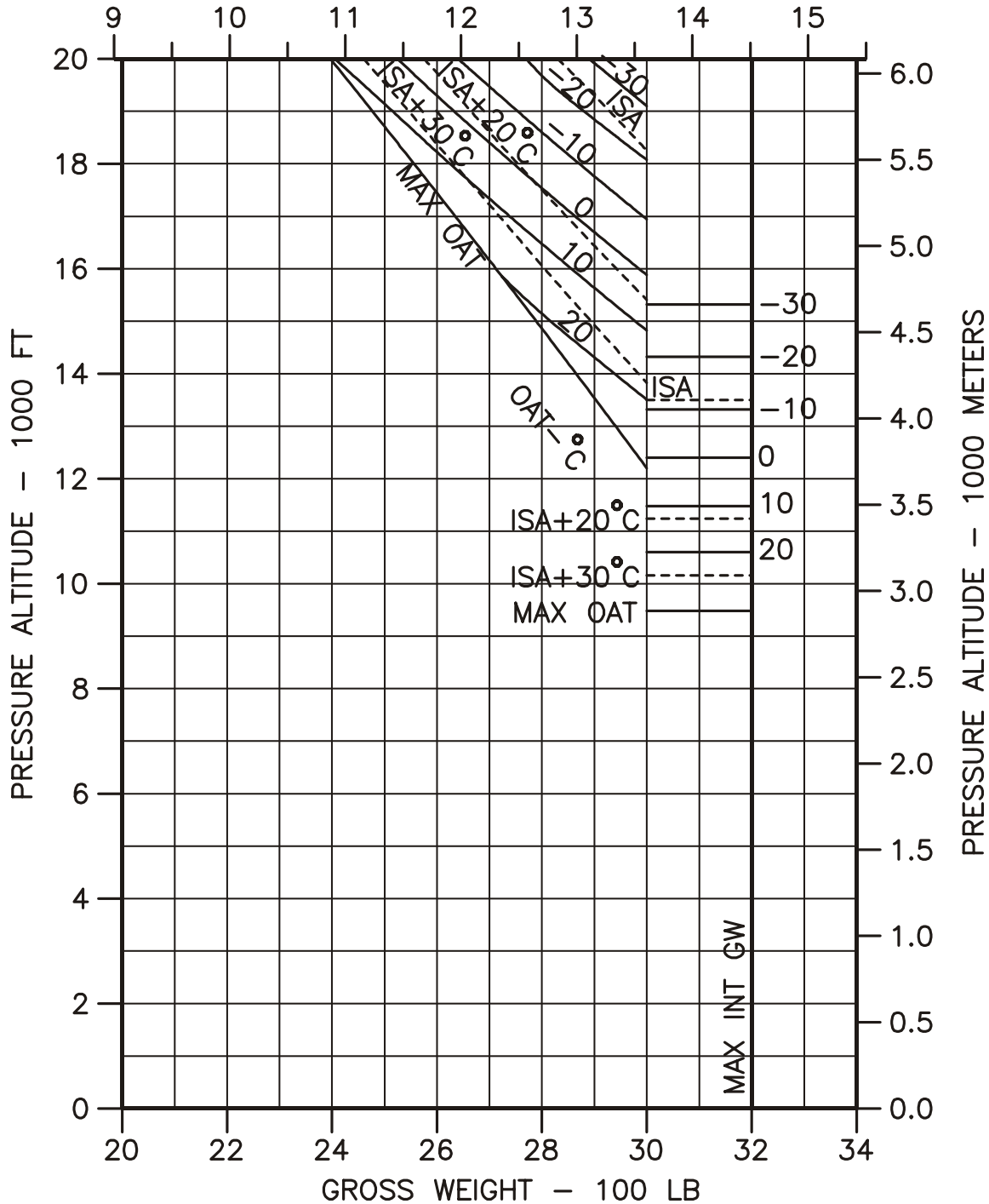

NOTE: MAXIMUM OPERATING ALTITUDE FOR ALL GROSS WEIGHTS ABOVE 3000 POUNDS/1361 KILOGRAMS IS 13,500 FEET / 4115 METERS **DENSITY ALTITUDE**.

THE DATA SET FORTH ON THIS DOCUMENT ARE GENERAL IN NATURE AND MAY VARY WITH CONDITIONS. FOR PERFORMANCE DATA AND OPERATING LIMITATIONS FOR ANY SPECIFIC FLIGHT MISSION, REFERENCE MUST BE MADE TO THE APPROVED FLIGHT MANUAL.



## SERVICE CEILING

**OPTIONAL, ROLLS-ROYCE 250-C20 R ENGINE, BASIC INLET AT MCP  
100 FPM (0.5 M/S) RATE OF CLIMB**

GROSS WEIGHT – 100 KG

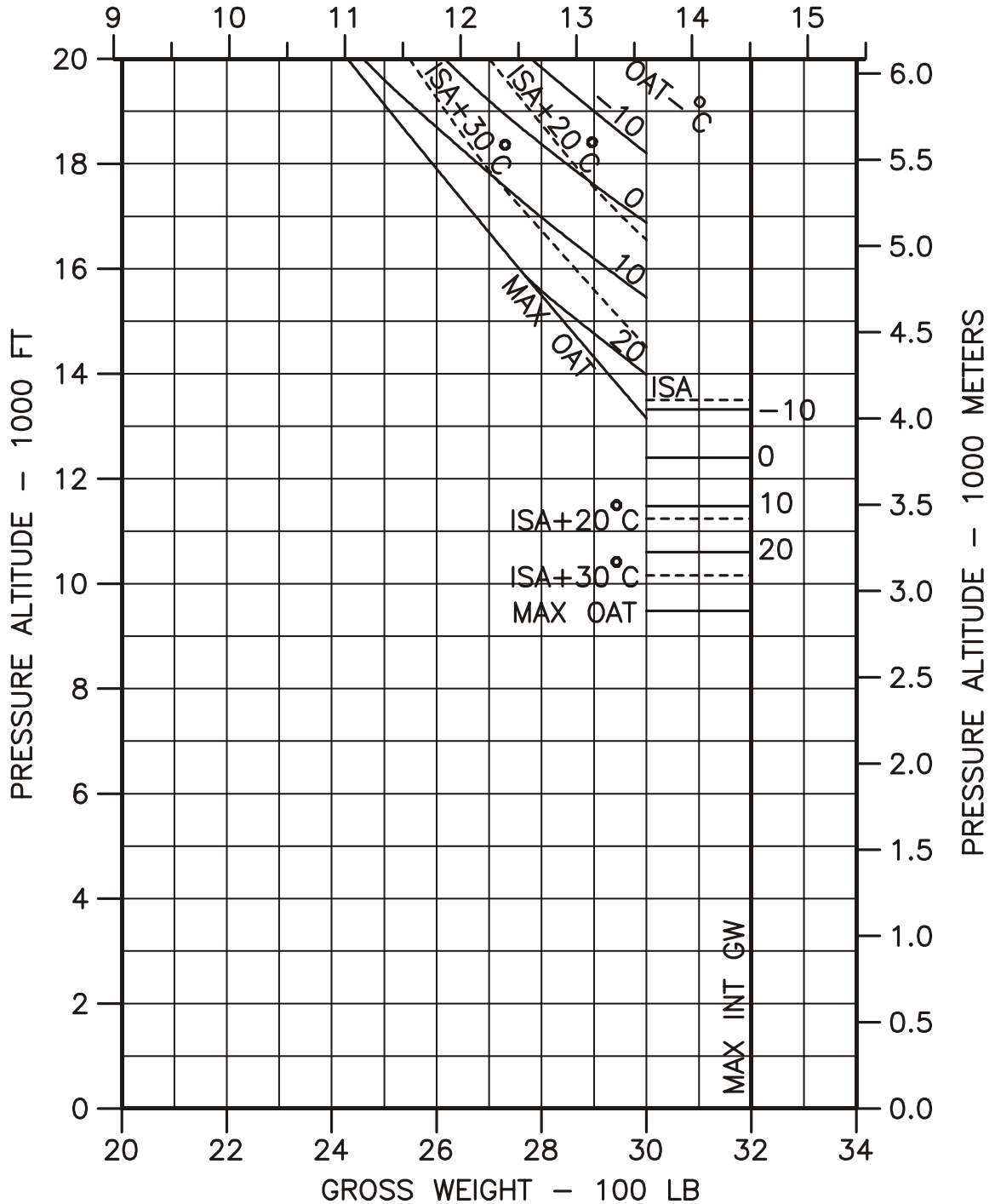

NOTE: MAXIMUM OPERATING ALTITUDE FOR ALL GROSS WEIGHTS ABOVE 3000 POUNDS/1361 KILOGRAMS IS 13,500 FEET / 4115 METERS **DENSITY ALTITUDE**.

THE DATA SET FORTH ON THIS DOCUMENT ARE GENERAL IN NATURE AND MAY VARY WITH CONDITIONS. FOR PERFORMANCE DATA AND OPERATING LIMITATIONS FOR ANY SPECIFIC FLIGHT MISSION, REFERENCE MUST BE MADE TO THE APPROVED FLIGHT MANUAL.



INTENTIONALLY LEFT BLANK



**FUEL FLOW vs AIRSPEED**  
**ISA & ISA+20° C**  
**ROLLS-ROYCE 250-C20B/J ENGINE**  
**BASIC INLET INSTALLED**  
**LOW SKID GEAR WITHOUT FAIRINGS**  
FOR PARTICLE SEPARATOR INSTALLED;  
INCREASE FUEL FLOW TWO(2)LB/HR[ONE(1)KG/HR]  
FOR CROSS TUBE FAIRINGS;  
INCREASE AIRSPEED TWO(2)KNOTS[FOUR(4)KM/HR]

**NOTE: THE BEST ALLOWABLE CRUISE SPEED IS EITHER LONG RANGE CRUISE SPEED [LRC], OR WHEN SPEED IS LIMITED BY MAXIMUM CONTINUOUS CRUISE POWER [MCP] OR  $V_{NE}$ , THE MAXIMUM SPEED PERMITTED .**



**FUEL FLOW**  
**ROLLS-ROYCE 250-C20B/J ENGINE**  
**PRESSURE ALTITUDE = SEA LEVEL**  
**OAT = +15°C**

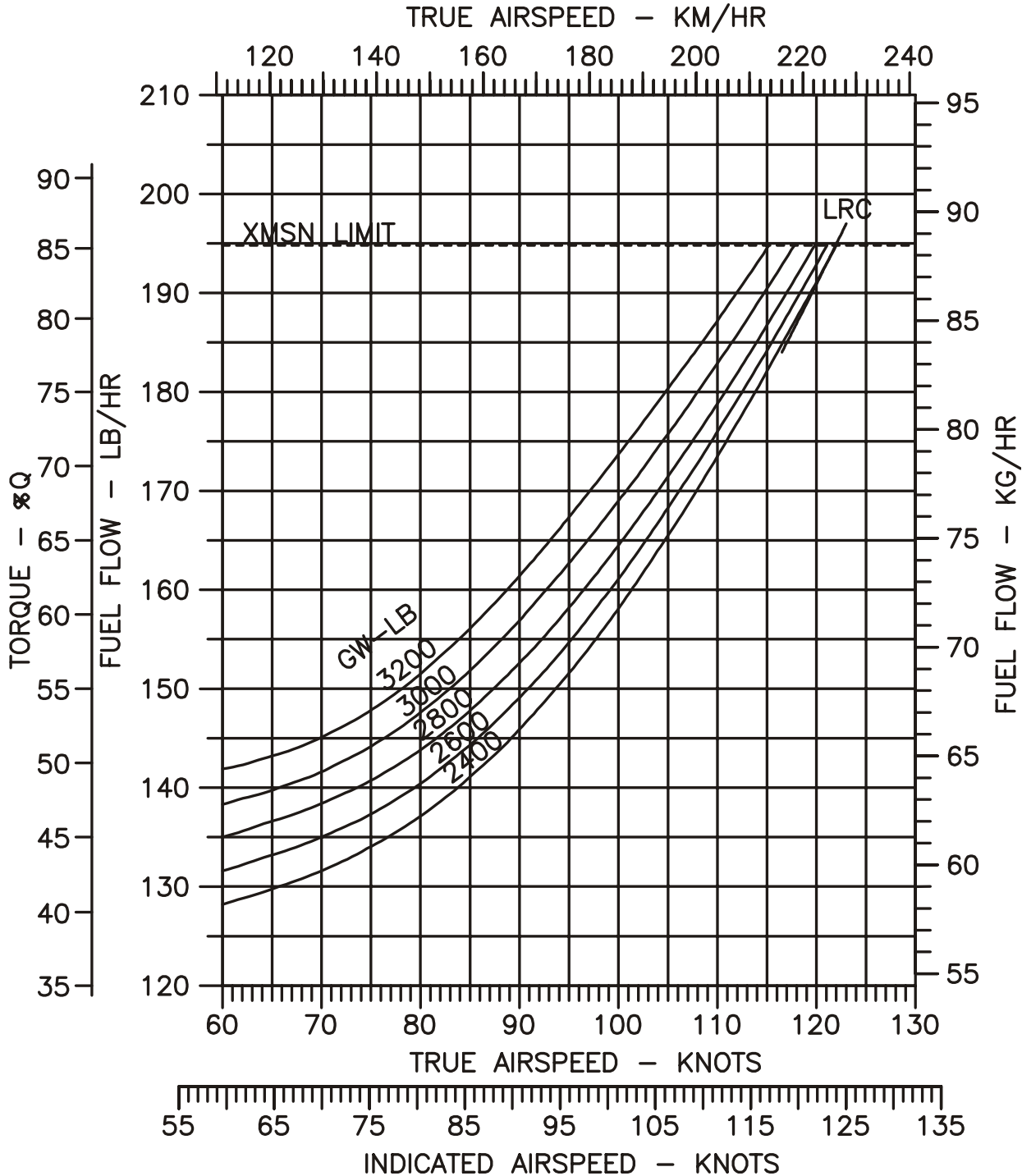

THE DATA SET FORTH ON THIS DOCUMENT ARE GENERAL IN NATURE AND MAY VARY WITH CONDITIONS. FOR PERFORMANCE DATA AND OPERATING LIMITATIONS FOR ANY SPECIFIC FLIGHT MISSION, REFERENCE MUST BE MADE TO THE APPROVED FLIGHT MANUAL.



**FUEL FLOW**  
**ROLLS-ROYCE 250-C20B/J ENGINE**  
**PRESSURE ALTITUDE = 2000 FEET**  
**OAT = +11°C**

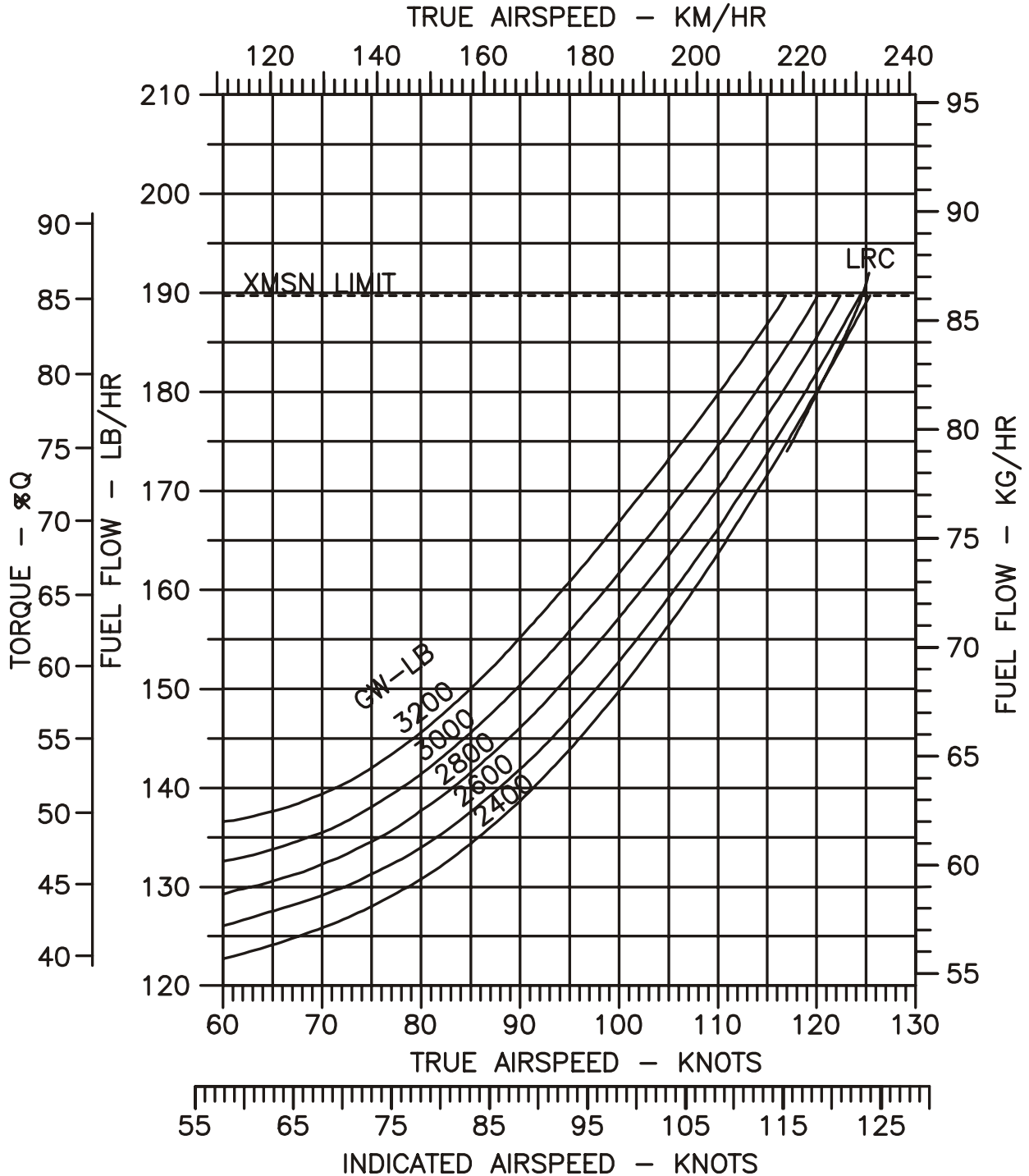

THE DATA SET FORTH ON THIS DOCUMENT ARE GENERAL IN NATURE AND MAY VARY WITH CONDITIONS. FOR PERFORMANCE DATA AND OPERATING LIMITATIONS FOR ANY SPECIFIC FLIGHT MISSION, REFERENCE MUST BE MADE TO THE APPROVED FLIGHT MANUAL.



**FUEL FLOW**  
**ROLLS-ROYCE 250-C20B/J ENGINE**  
**PRESSURE ALTITUDE = 4000 FEET**  
**OAT = +7°C**

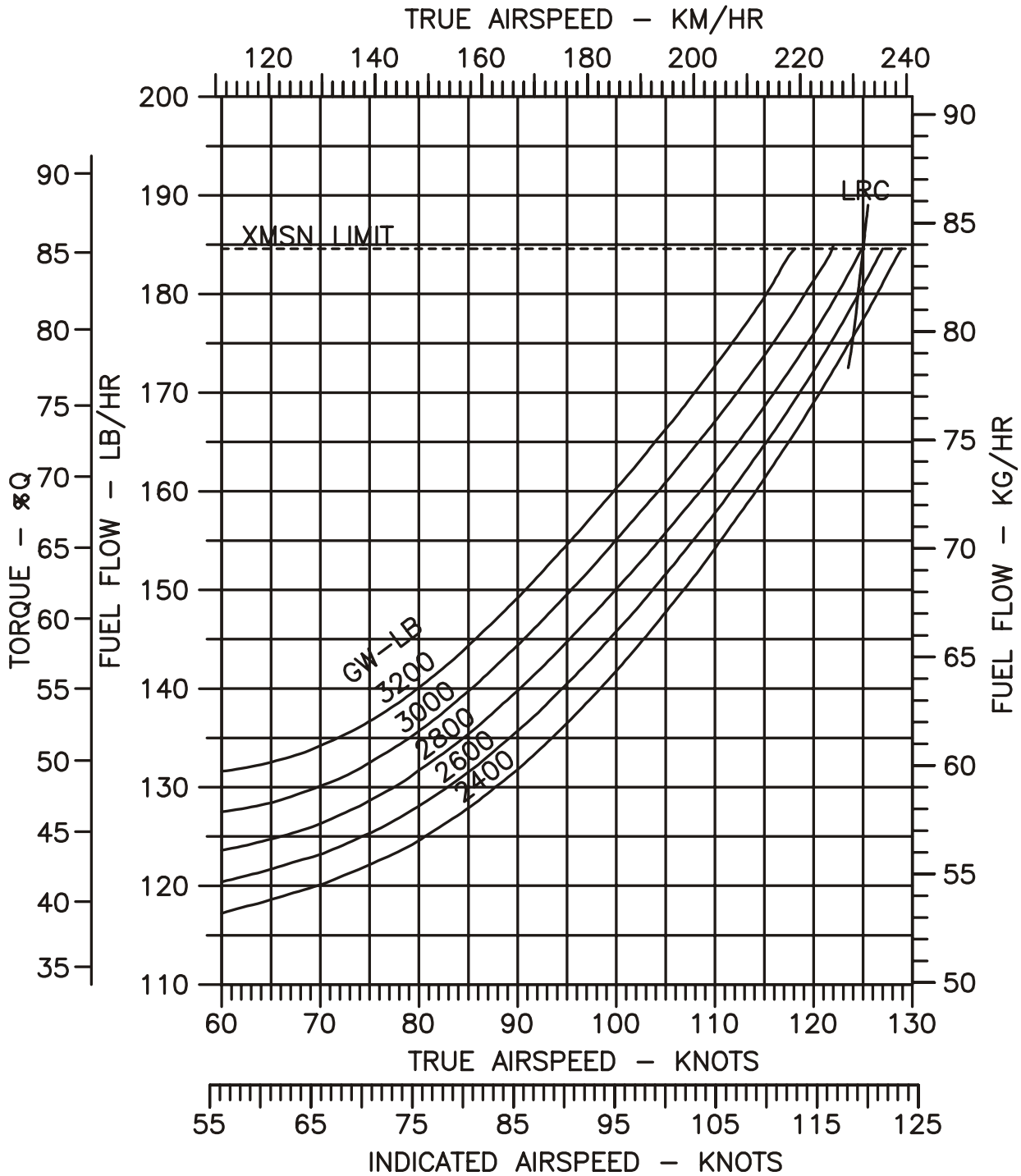

THE DATA SET FORTH ON THIS DOCUMENT ARE GENERAL IN NATURE AND MAY VARY WITH CONDITIONS. FOR PERFORMANCE DATA AND OPERATING LIMITATIONS FOR ANY SPECIFIC FLIGHT MISSION, REFERENCE MUST BE MADE TO THE APPROVED FLIGHT MANUAL.



**FUEL FLOW**  
**ROLLS-ROYCE 250-C20B/J ENGINE**  
**PRESSURE ALTITUDE = 6000 FEET**  
**OAT = +3°C**

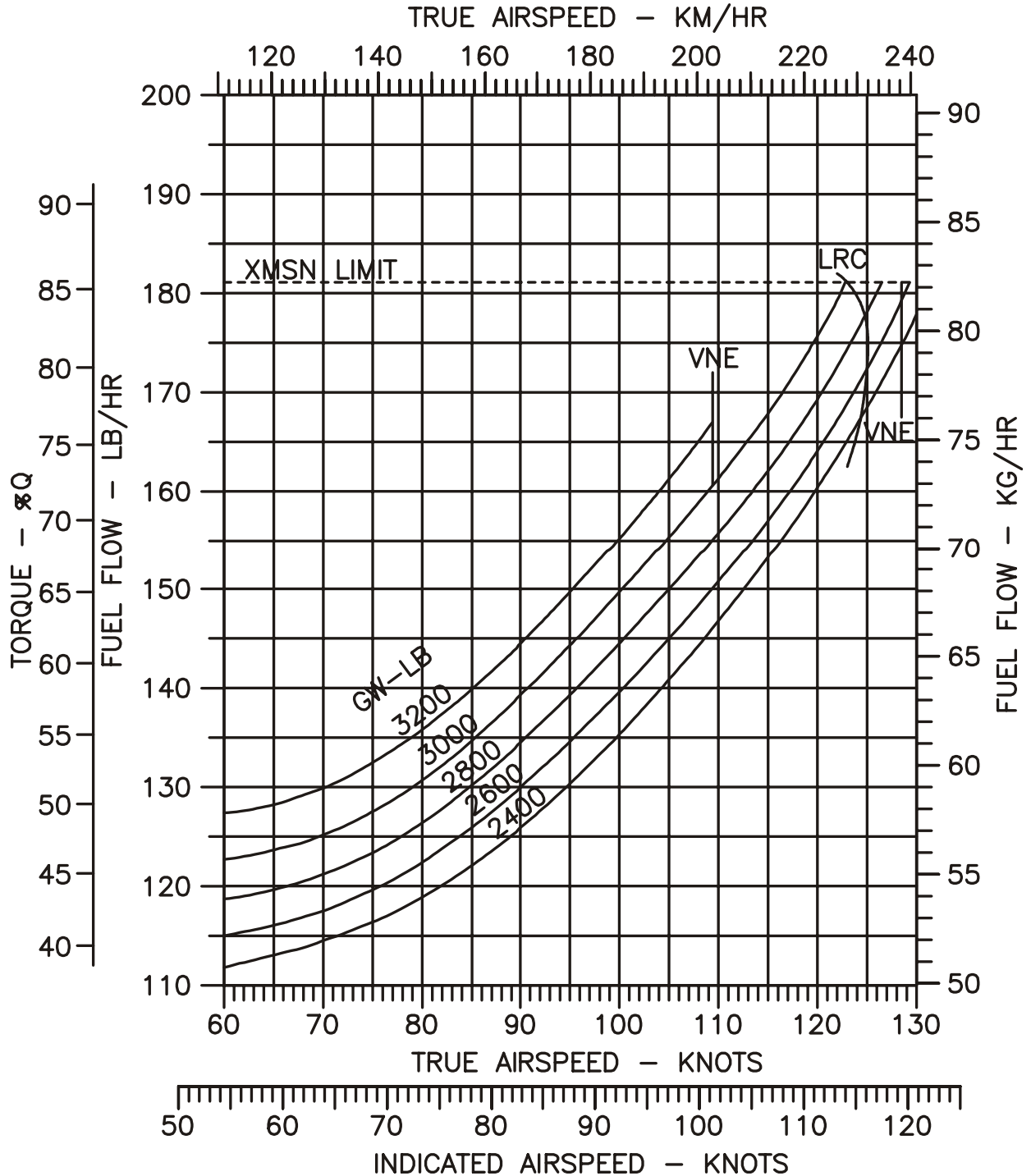

THE DATA SET FORTH ON THIS DOCUMENT ARE GENERAL IN NATURE AND MAY VARY WITH CONDITIONS. FOR PERFORMANCE DATA AND OPERATING LIMITATIONS FOR ANY SPECIFIC FLIGHT MISSION, REFERENCE MUST BE MADE TO THE APPROVED FLIGHT MANUAL.



**FUEL FLOW**  
**ROLLS-ROYCE 250-C20B/J ENGINE**  
**PRESSURE ALTITUDE = 8000 FEET**  
**OAT = -1°C**

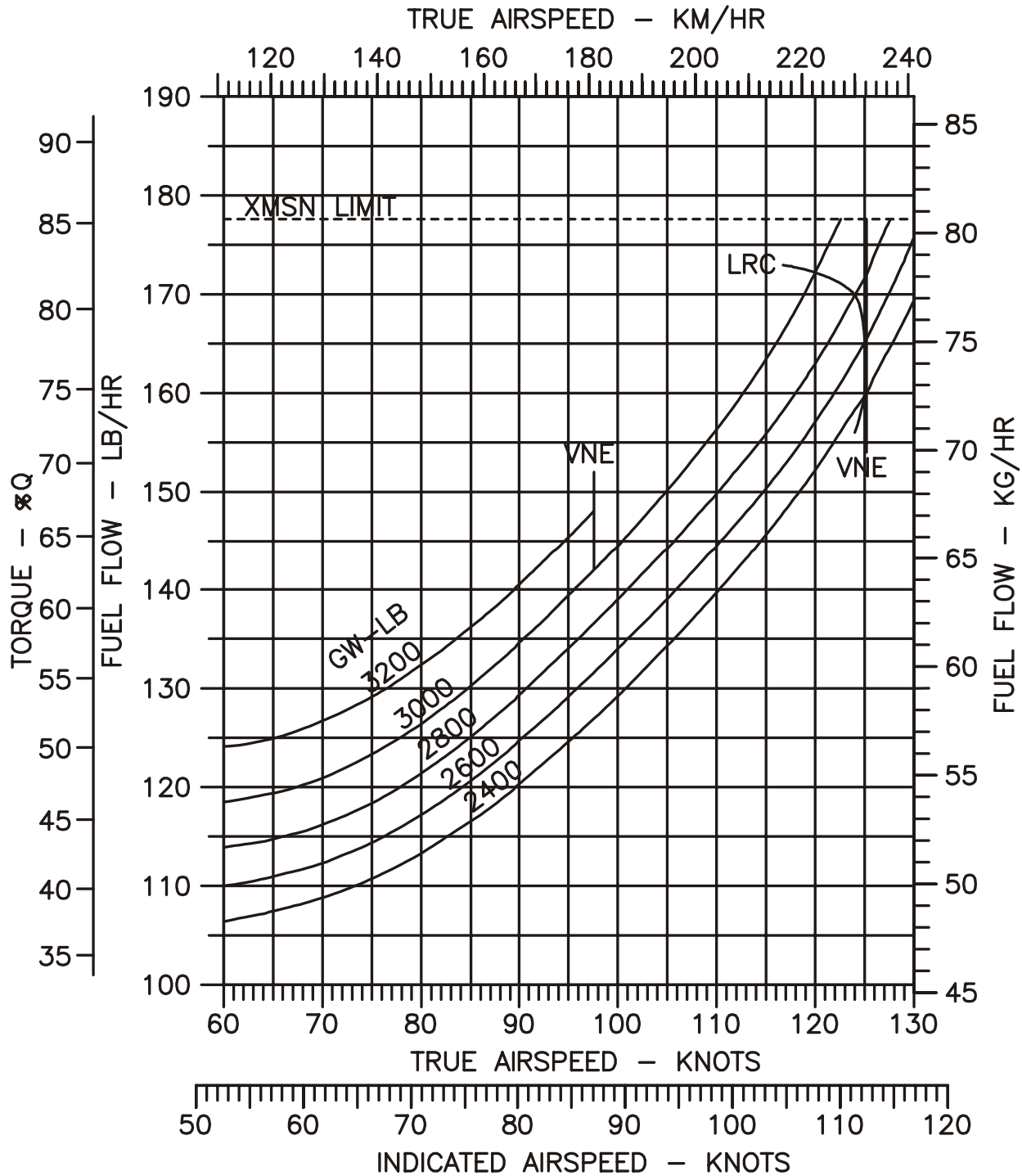

THE DATA SET FORTH ON THIS DOCUMENT ARE GENERAL IN NATURE AND MAY VARY WITH CONDITIONS. FOR PERFORMANCE DATA AND OPERATING LIMITATIONS FOR ANY SPECIFIC FLIGHT MISSION, REFERENCE MUST BE MADE TO THE APPROVED FLIGHT MANUAL.



**FUEL FLOW**  
**ROLLS-ROYCE 250-C20B/J ENGINE**  
**PRESSURE ALTITUDE = SEA LEVEL**  
**OAT = +35°C**

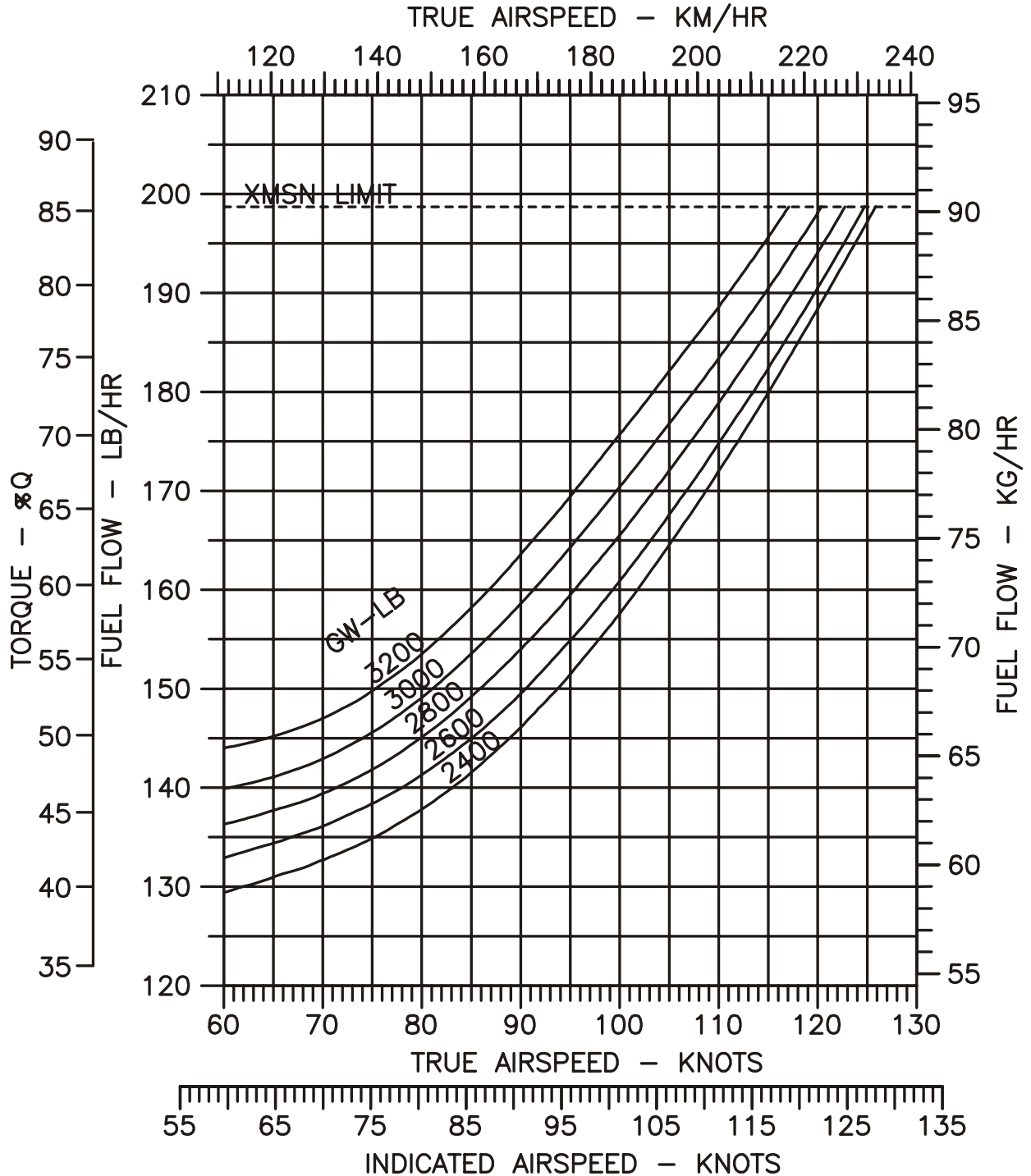

THE DATA SET FORTH ON THIS DOCUMENT ARE GENERAL IN NATURE AND MAY VARY WITH CONDITIONS. FOR PERFORMANCE DATA AND OPERATING LIMITATIONS FOR ANY SPECIFIC FLIGHT MISSION, REFERENCE MUST BE MADE TO THE APPROVED FLIGHT MANUAL.



**FUEL FLOW**  
**ROLLS-ROYCE 250-C20B/J ENGINE**  
**PRESSURE ALTITUDE = 2000 FEET**  
**OAT = +31°C**

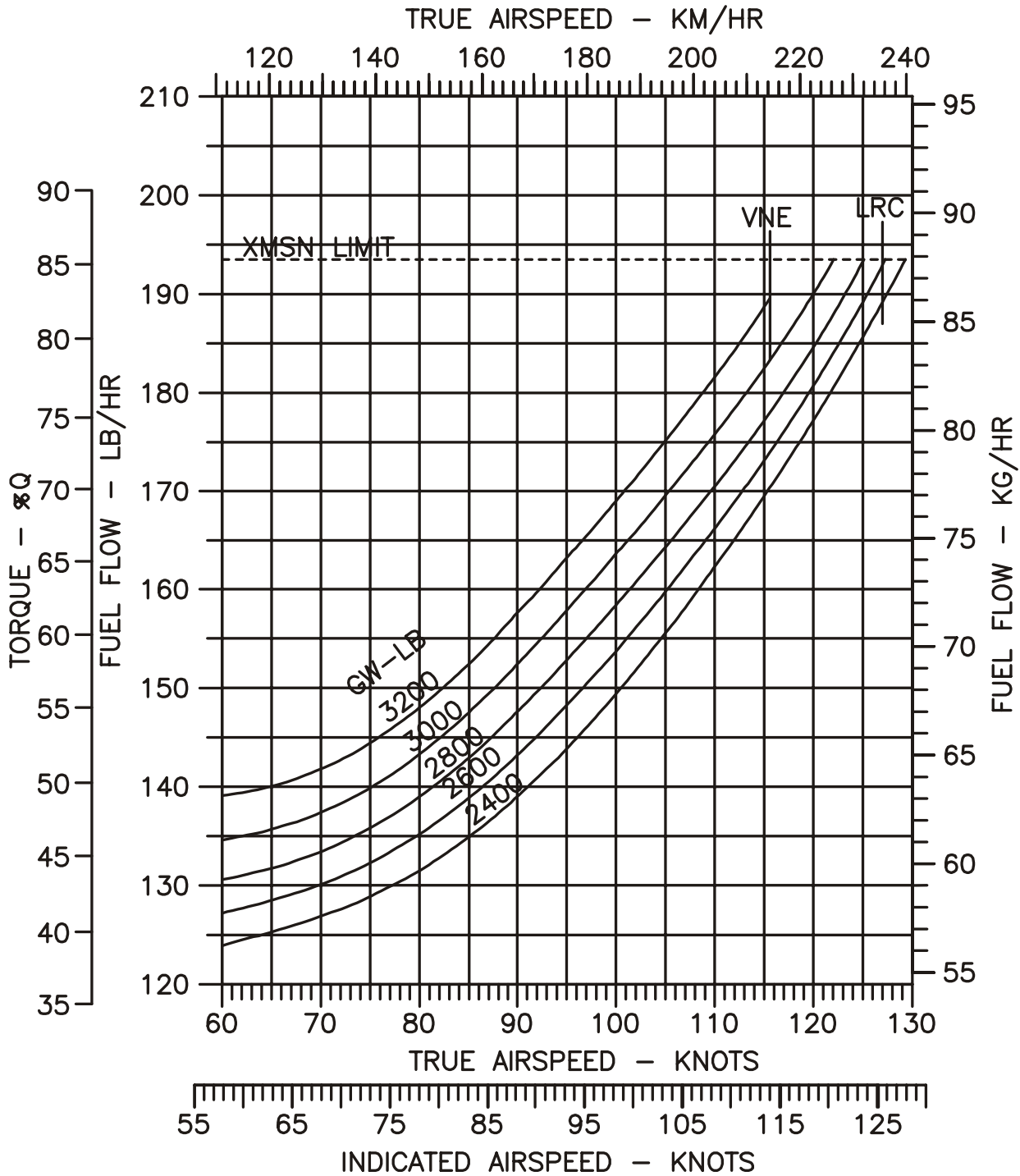

THE DATA SET FORTH ON THIS DOCUMENT ARE GENERAL IN NATURE AND MAY VARY WITH CONDITIONS. FOR PERFORMANCE DATA AND OPERATING LIMITATIONS FOR ANY SPECIFIC FLIGHT MISSION, REFERENCE MUST BE MADE TO THE APPROVED FLIGHT MANUAL.



**FUEL FLOW**  
**ROLLS-ROYCE 250-C20B/J ENGINE**  
**PRESSURE ALTITUDE = 4000 FEET**  
**OAT = +27°C**

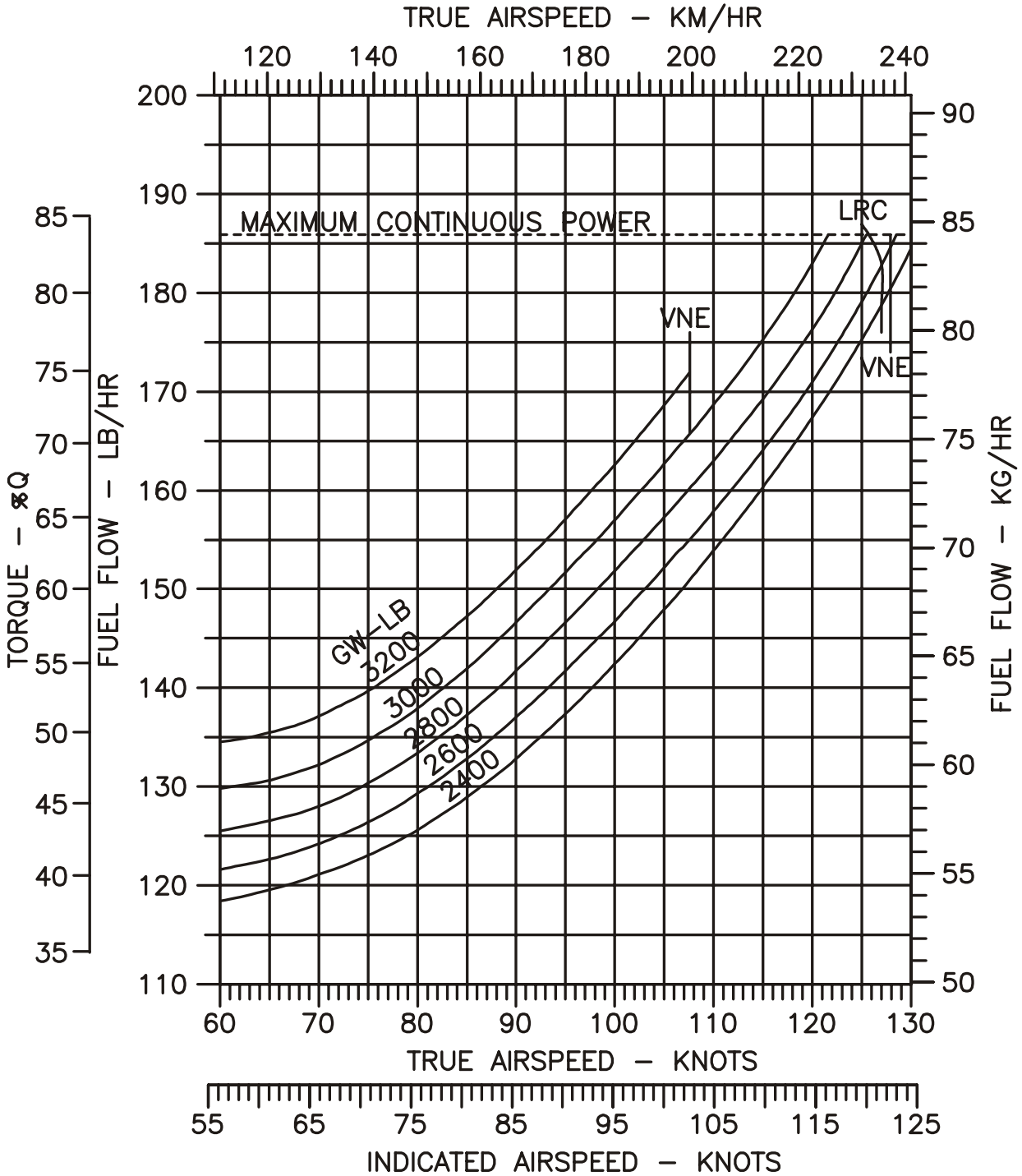

THE DATA SET FORTH ON THIS DOCUMENT ARE GENERAL IN NATURE AND MAY VARY WITH CONDITIONS. FOR PERFORMANCE DATA AND OPERATING LIMITATIONS FOR ANY SPECIFIC FLIGHT MISSION, REFERENCE MUST BE MADE TO THE APPROVED FLIGHT MANUAL.



**FUEL FLOW**  
**ROLLS-ROYCE 250-C20B/J ENGINE**  
**PRESSURE ALTITUDE = 6000 FEET**  
**OAT = +23° C**

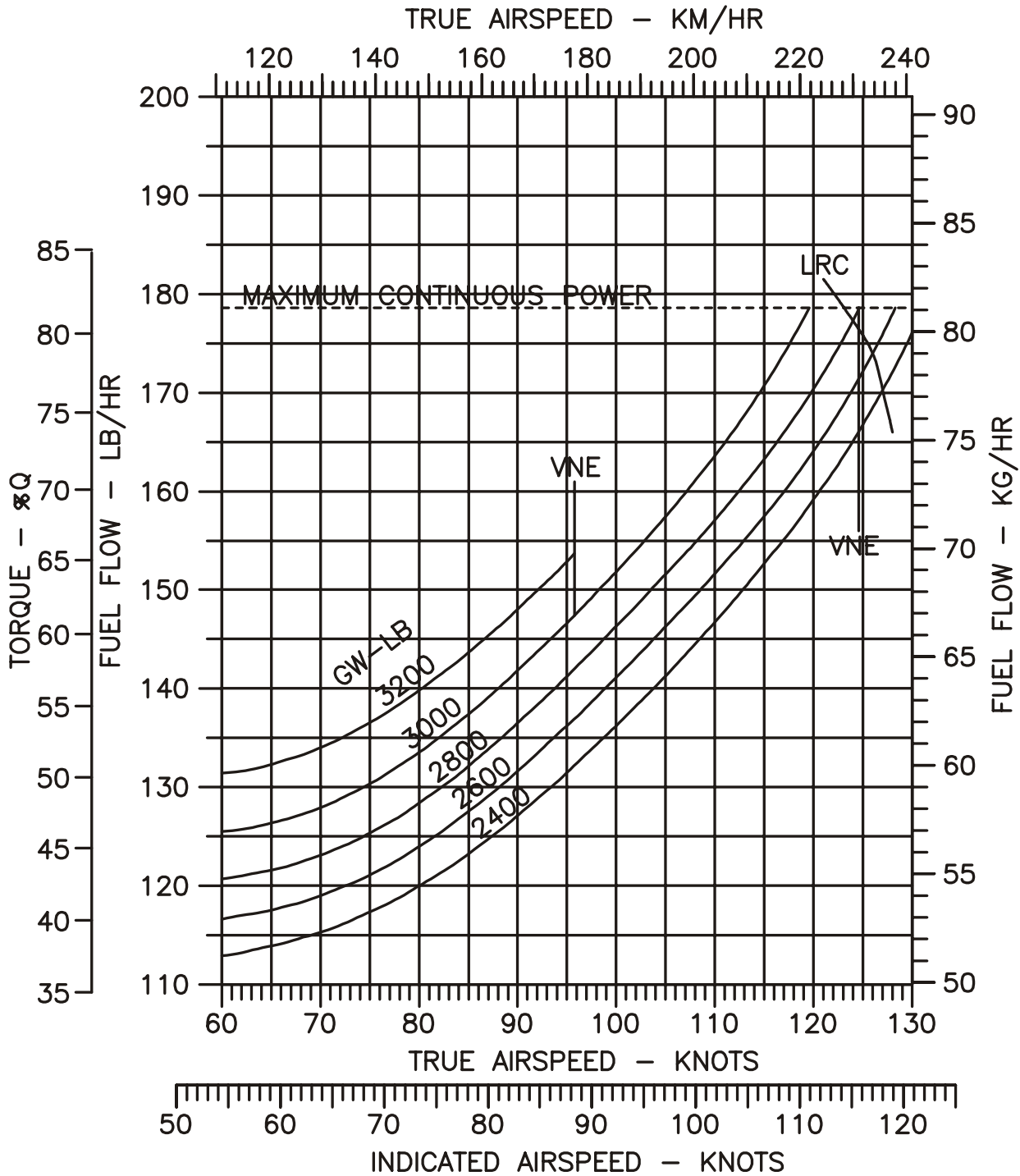

THE DATA SET FORTH ON THIS DOCUMENT ARE GENERAL IN NATURE AND MAY VARY WITH CONDITIONS. FOR PERFORMANCE DATA AND OPERATING LIMITATIONS FOR ANY SPECIFIC FLIGHT MISSION, REFERENCE MUST BE MADE TO THE APPROVED FLIGHT MANUAL.



**FUEL FLOW**  
**ROLLS-ROYCE 250-C20B/J ENGINE**  
**PRESSURE ALTITUDE = 8000 FEET**  
**OAT = +19°C**

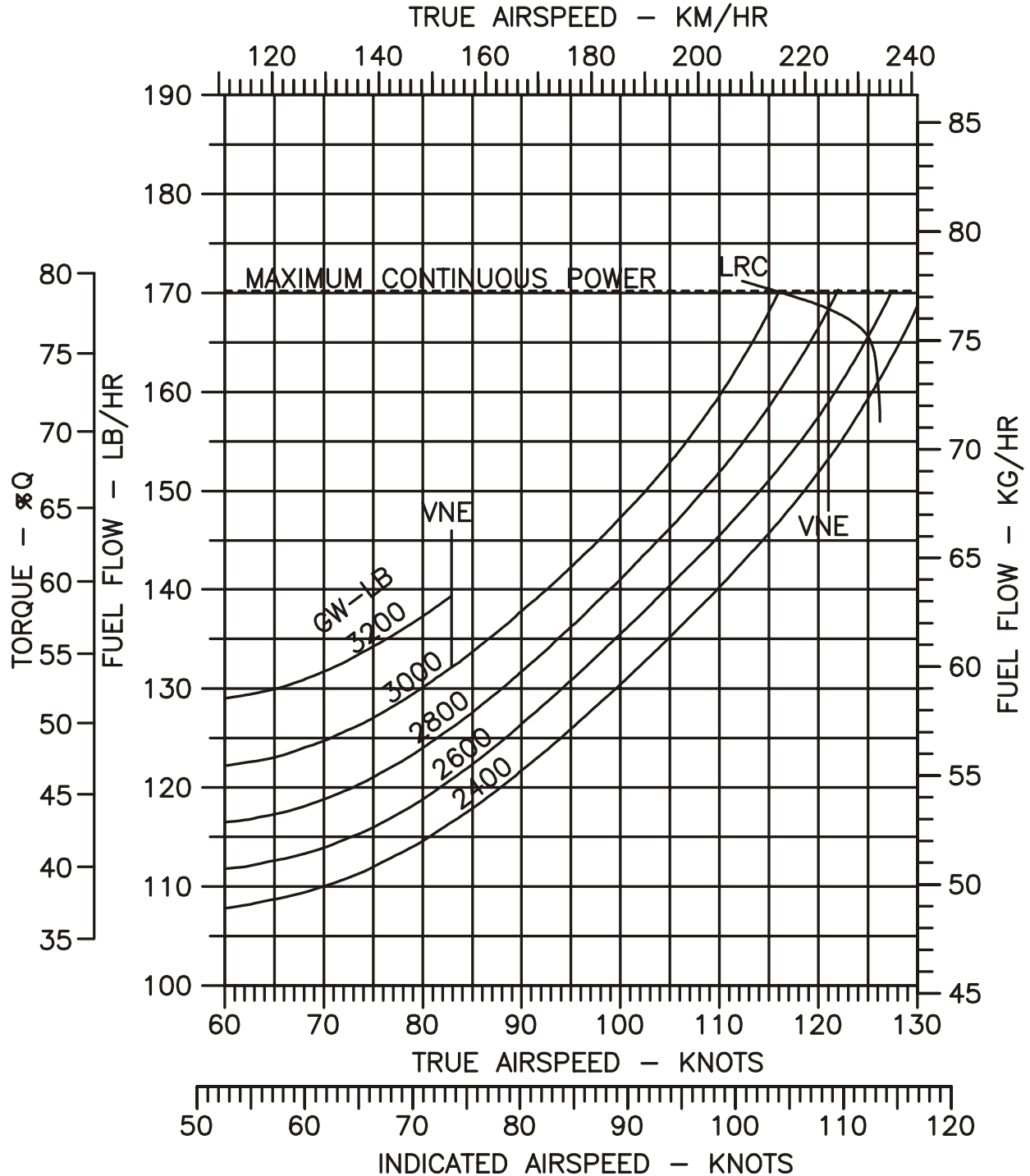

THE DATA SET FORTH ON THIS DOCUMENT ARE GENERAL IN NATURE AND MAY VARY WITH CONDITIONS. FOR PERFORMANCE DATA AND OPERATING LIMITATIONS FOR ANY SPECIFIC FLIGHT MISSION, REFERENCE MUST BE MADE TO THE APPROVED FLIGHT MANUAL.



## **COST OF OPERATIONS**

### **INTRODUCTION**

Bell Helicopter Textron's cost of operations data for current production helicopters is based on information from Bell operators and service facilities.

BHT's Product Support organization accumulates cost data from a diverse group of operators - large, small; sub-polar, subtropical; inland, coastal; corporate, charter. This information is analyzed to generate sample data for each production model which are averages of the field experience.

BHT intends to continue monitoring actual costs to enable annual updates of the data to maintain its currency.

The following discussion is provided to review the variables involved in the helicopter's direct and indirect cost of operations as well as its cost of ownership.

The total cost of helicopter ownership and operation involves both direct and indirect costs. The direct costs are those which are incurred essentially by the flight hour and include:

- Fuel, Lubricants
- Basic Airframe Maintenance
- Powerplant Maintenance

The indirect costs are not directly dependent upon the number of hours flown and include:

- Insurance
- Facilities (hangar, workshop, etc.)
- Crew Compensation
- Financial Factors (depreciation, investment tax credit, financing costs, etc.)

Sample direct operating cost data is available for each current production model. Detailed estimates for total costs relating to specific operations are available through the BHT regional marketing manager or corporate office using input data supplied by customer/prospect.

### **DIRECT COSTS**

#### **Fuel, Lubricants**

A typical average value of fuel and lubricant costs is included in the sample data provided for each model.

Fuel consumption depends upon speed, temperature, externally-mounted accessories, sling loads, etc. A band of approximately 10% more or less than sample value will cover these factors for normal operations.

Fuel pricing varies considerably based on where the fuel is purchased geographically and whether it is purchased retail or in bulk. The sample cases use average retail purchase price prevalent at the time of the sample data are prepared.

#### **Basic Airframe Maintenance**

Airframe maintenance is divided into four categories:

- Periodic Inspections
- Overhauls
- Replacement of Retirement Parts
- Unscheduled

Periodic inspections include those inspection tasks, with their part requirements, listed in the Maintenance Manual for each model.

Man hours for periodic inspections can vary from the sample value provided because of differences in personal experience, tool and parts availability, facilities, environmental effects such as extremes in working temperatures. Man hour costs/hour are also variable among the Authorized Service Centers as a result of differences in local costs, overhead expenses and volume of work. The sample value is an average of costs per hour at Authorized Service Centers at the time of publication.

Overhauls include removal, disassembly, inspection, parts replacement, reassembly and reinstallation of certain components/assemblies at the periods stated in the BHT Maintenance Manual.

Overhaul man hour and parts requirements are subject to considerable variation depending upon the helicopter's operations and environments. The sample data reflect average values.



## **COST OF OPERATIONS (continued)**

Retirement parts are those which are subject to disposal after an operating time stated in the Maintenance Manual. These are normally components of the rotors/control systems which are subject to oscillatory loads and are designed and tested for use over a finite number of flight hours rather than on their condition. The replacement at the required intervals requires some labor which is included in the man hour data in the sample.

Unscheduled maintenance encompasses labor and parts replacement for major maintenance not covered under the formal Maintenance Manual requirements for inspections and overhauls. It also includes those additional maintenance requirements imposed by the manufacturer through issue of Service Bulletins.

The sample data for periodic inspections provide for some minor unscheduled maintenance tasks resulting from the inspection.

### **Powerplant Maintenance**

The powerplant (engine [s]) requires periodic inspection and overhauls. The overhaul periods are based on the number of operating hours or on the number of cycles, whichever is the first limit to be attained. Start cycles are a factor because thermal cycles are important in the design of the turbine engine's rotating components. Overhauls are performed by the engine manufacturer and/or at authorized facilities.

Powerplant overhaul can be performed for the engine as a unit, or in some cases for individual modules. (Modules can be gearbox, compressor, turbine, for example.) Each module can have its own overhaul period. Modular overhaul can be cost-effective for some operations and its use should be evaluated.

Engine or module exchanges can be made in lieu of overhaul. For details, contact the engine manufacturer or his authorized distributors/service centers. The sample costs are based on an average exchange.

The powerplant may also require unscheduled maintenance (unscheduled removals for repair, parts replacement).

### **INDIRECT COSTS**

#### **Insurance**

Insurance rates are based on a number of factors including claim experience, type of operations, and crew qualifications. Rates can be obtained from insurance agent/broker.

#### **Facilities**

Facilities can include hangar, workshop, parts storage area, tools, ground support equipment and administrative area as appropriate to the specific operation.

#### **Crew Compensation**

The number of aircrew personnel depends on the individual operation; i. e., whether the normal crew consists of one or two pilots, hours per day flown, backup requirements for illness, vacation, etc.

Bell regional marketing managers can advise typical local costs for estimation purposes.

#### **Financial Factors**

Funding a helicopter purchase can be accomplished in a variety of ways, including cash, short term note, long term note, partnership, etc. For investment accounting, several depreciation methods also exist; straight line, double declining, sum of the years digits, etc. Value of resale is a significant factor.

#### **Miscellaneous Factors**

Staff expenses (other than aircrew and direct maintenance personnel), utilities, office expenses, etc.

### **OWNERSHIP ANALYSIS PROGRAM**

Bell Helicopter Textron uses the **Life Cycle Cost 2004** computer program provided by **Conklin & de Decker Associates, Inc.** to determine ownership costs for an operator's planned period of utilization for the aircraft. Conklin's Rotorcraft Analysis Office may be contacted at: Phone; (817)277-6403 or Fax; (817)277-6402.

Bell's regional marketing managers or corporate office personnel will be able to assist in preparing an ownership analysis which is customized for our customers specific individual conditions and needs.



**SAMPLE - COST OF OPERATIONS**  
**U S DOLLARS PER FLIGHT HOUR**

		<b><u>Operator Overhaul</u></b>
<u>Fuel and Lubricants</u>		
Fuel: ( <b>Note 1</b> ) [28 Gal/Hr]		\$42.00
Lubricants: 3% of Fuel Cost		1.26
<u>Airframe Direct Maintenance</u>		
Labor: ( <b>Note 2</b> )		
Inspection	(0.300 MH/FH)	14.98
Overhaul	(0.103 MH/FH)	6.63
Unscheduled and on-condition	(0.354 MH/FH)	17.69
Parts:		
Inspections		2.45
Retirement		34.52
Overhaul		17.95
Unscheduled and on-condition		30.86
<u>Powerplant Direct Maintenance</u>		
Overhaul (Including Accessories- <b>Note 3</b> )		
49.80		
Line Maintenance (labor)	(0.067 MH/FH)	3.33
<b><u>TOTAL AVERAGE COST / HR</u></b>		<b><u>\$221.47</u></b>

**Note 1:** Fuel at \$1.50 per gallon. Average fuel consumption for LRC at 1000 feet, ISA, ( Jet-A at 6.8 Lb/Gal.)

**Note 2:** Labor rate assumed at \$50.00 per hour; overhaul labor at \$65.00 per hour.

**Note 3:** Includes all scheduled and unscheduled maintenance and life limited parts replacement assuming normal operating environment.



## LIMITED LIFE COMPONENTS

<u>PART NUMBER</u>	<u>COMPONENT</u>	<u>LIFE (FLT HRS)</u>	<u>QTY PER A/C</u>	<u>LIST PRICE EA</u>	<u>TOTAL COST (FLT HR)</u>
<b>MAIN ROTOR HUB AND BLADE</b>					
206-010-200-133	Main Rotor Blade	5,000	2	30,488.00 \$	12.20
206-011-113-103	Main Rotor Trunnion	4,800	1	2,168.00 \$	0.45
206-011-125-105	Main Rotor Strap Pin	2,500	2	366.00 \$	0.29
206-011-132-113A	Main Rotor Grip	4,800	2	7,224.00 \$	3.01
206-011-150-105	Retention Strap Fitting	2,400	2	1,627.00 \$	1.36
206-011-154-107	Tension-Torsion Strap	1,200	2	3,506.00 \$	5.84
206-011-260-103	Retention Strap Bolt	2,500	2	621.00 \$	0.50
<b>MAIN ROTOR CONTROLS</b>					
206-001-194-001	Lower Collective Tube	4,800	1	674.00 \$	0.14
206-001-566-101	Servo Actuator Support	10,000	1	11,148.00 \$	1.11
206-010-407-001	Collective Lever Idler Link	4,800	1	843.00 \$	0.18
206-010-452-113	Swashplate Support	4,800	1	6,030.00 \$	1.26
206-010-454-109	Swashplate Sleeve Assy	4,800	1	3,238.00 \$	0.67
206-010-467-105	Collective Lever	4,800	1	1,220.00 \$	0.25
<b>POWERTRAIN</b>					
CL42250-1	Freewheeling Unit Clutch	3,000	1	2,108.00 \$	0.70
<b>TAIL ROTOR HUB AND BLADE</b>					
206-011-819-109	Tail Rotor Yoke	5,000	1	4,557.00 \$	0.91
206-016-201-131	Tail Rotor Blade	2,500	2	5,848.00 \$	4.68
206-011-803-005	Tail Rotor Trunnion	2400	1	1,158.00 \$	0.48
<b>TAIL ROTOR GEARBOX</b>					
206-040-410-101	Duplex Bearing	3,000	1	1,460.00 \$	0.49
<b>TOTAL</b>					<b>\$ 34.52</b>
					<b>per FH</b>

### COMPONENT OVERHAUL INTERVALS (HOURS)

M/R Hub	2,400	Freewheeling Assy	3,000	T/R Hub	2,500
Mast Assy	3,000	Swashplate & Support	4,800	Hyd Pump/Resv & Servos	3,600
Transmission	4,500	T/R Gearbox	6,000	T/R Drive System	3000/3 yrs

**Prices and hours are subject to change without notice.**

THESE DATA ARE PROVIDED FOR ILLUSTRATION PURPOSES. CONSULT MAINTENANCE DOCUMENTS AND BHT SPARE PARTS PRICING FOR CURRENT, OFFICIAL INFORMATION.

*For additional information visit the Bell Helicopter Textron Website*

*Homepage: [www.bellhelicopter.com](http://www.bellhelicopter.com)*

**Sales Contact Telephone Numbers**

Sales Inquiries

U.S. Toll Free: 800-FLY-BELL

International/US: 817-280-2800

Email: [marketing@bellhelicopter.textron.com](mailto:marketing@bellhelicopter.textron.com)

**Regional Sales Managers**

US/Canada 817-280-3601

Asia Pacific 817-280-2197

Europe/Middle East/Africa 817-280-3261

Latin America 817-280-2713

Fax: 817-280-5037

**Marketing Home Office**

*Bell Helicopter Textron Inc.*

*Plant 8, Bldg 40*

*POB 482*

*Fort Worth, TX 76101-0482*

*[marketing@bellhelicopter.textron.com](mailto:marketing@bellhelicopter.textron.com)*

**Manufacturing Facility**

*Bell Helicopter Textron Canada Inc*

*12,800 rue de l'Avenir*

*Mirabel, Quebec*

*Canada J7J 1R4*

*Fax: 450-437-2006*

*This book was produced by*



Visual Communications Center

POB 482

Ft Worth, TX 76101-0482

CUSTOMER \_\_\_\_\_  
 SERIAL NO. \_\_\_\_\_  
 REGISTRATION NO. \_\_\_\_\_

# Bell 206B3

## Standard Scheme A #206B-5/99-A

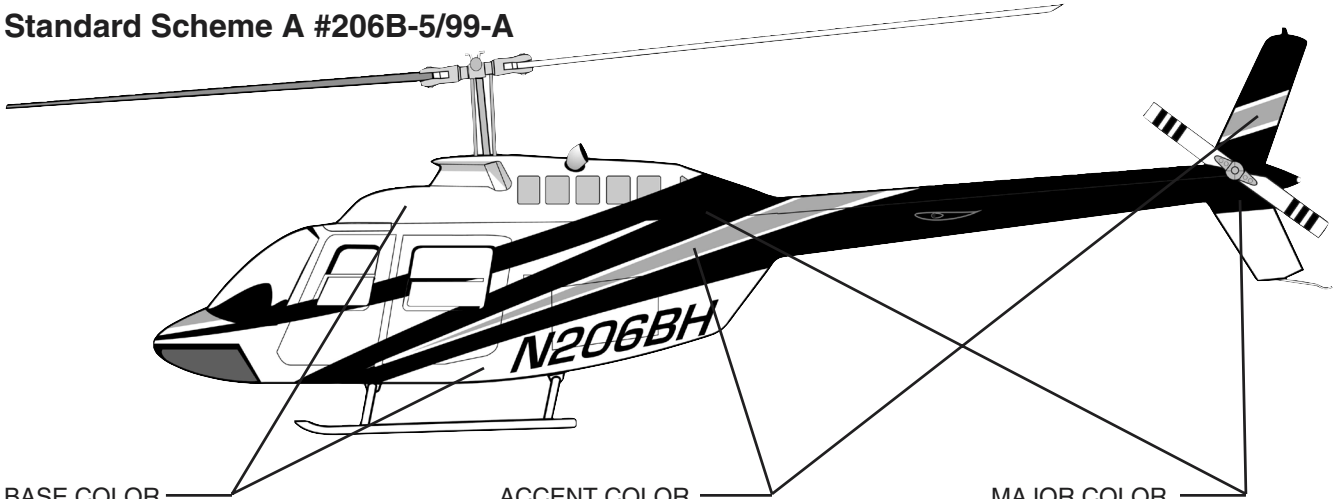

BASE COLOR _____	ACCENT COLOR _____	MAJOR COLOR _____
NAME _____	NAME _____	NAME _____
NUMBER _____	NUMBER _____	NUMBER _____

## Standard Scheme B #206B-5/99-B

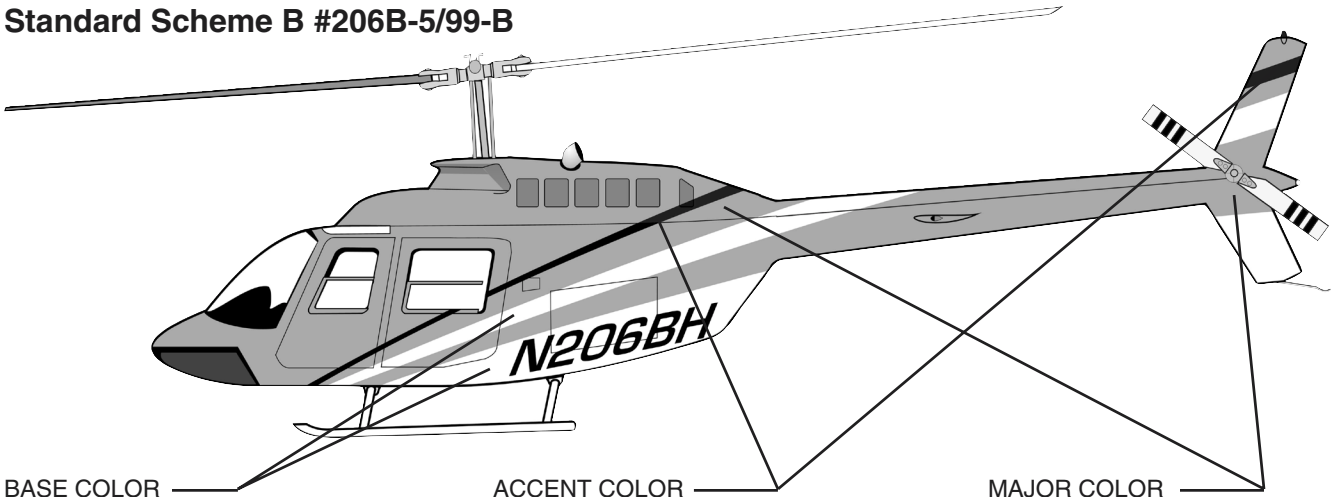

BASE COLOR _____	ACCENT COLOR _____	MAJOR COLOR _____
NAME _____	NAME _____	NAME _____
NUMBER _____	NUMBER _____	NUMBER _____

## Standard Scheme C #206B-5/99-C

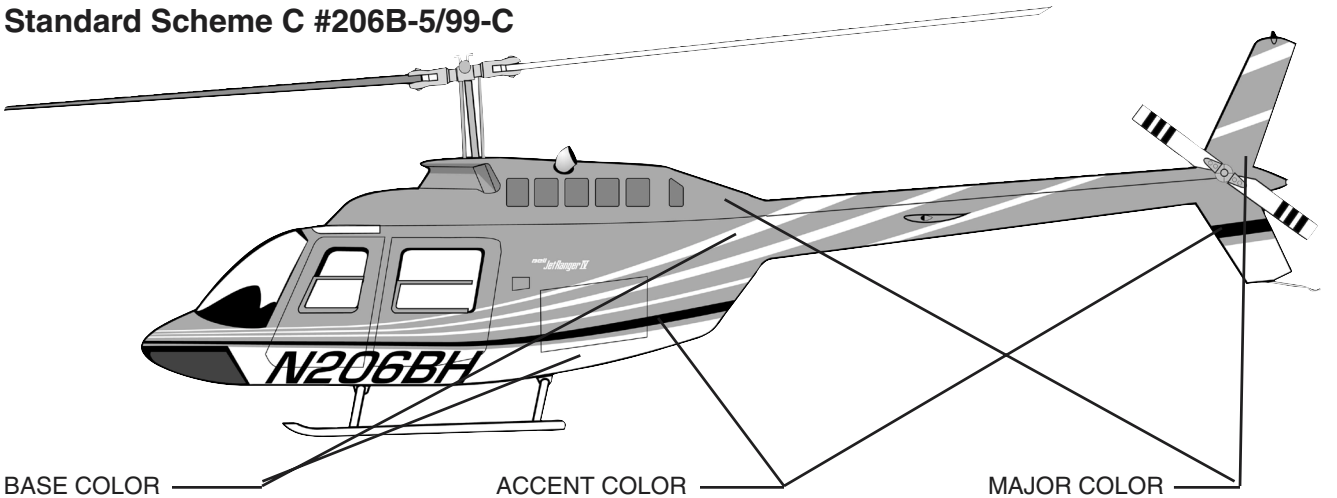

BASE COLOR _____	ACCENT COLOR _____	MAJOR COLOR _____
NAME _____	NAME _____	NAME _____
NUMBER _____	NUMBER _____	NUMBER _____

**Custom Scheme**

CUSTOMER \_\_\_\_\_  
SERIAL NO. \_\_\_\_\_  
REGISTRATION NO. \_\_\_\_\_

**BEH 200B3**

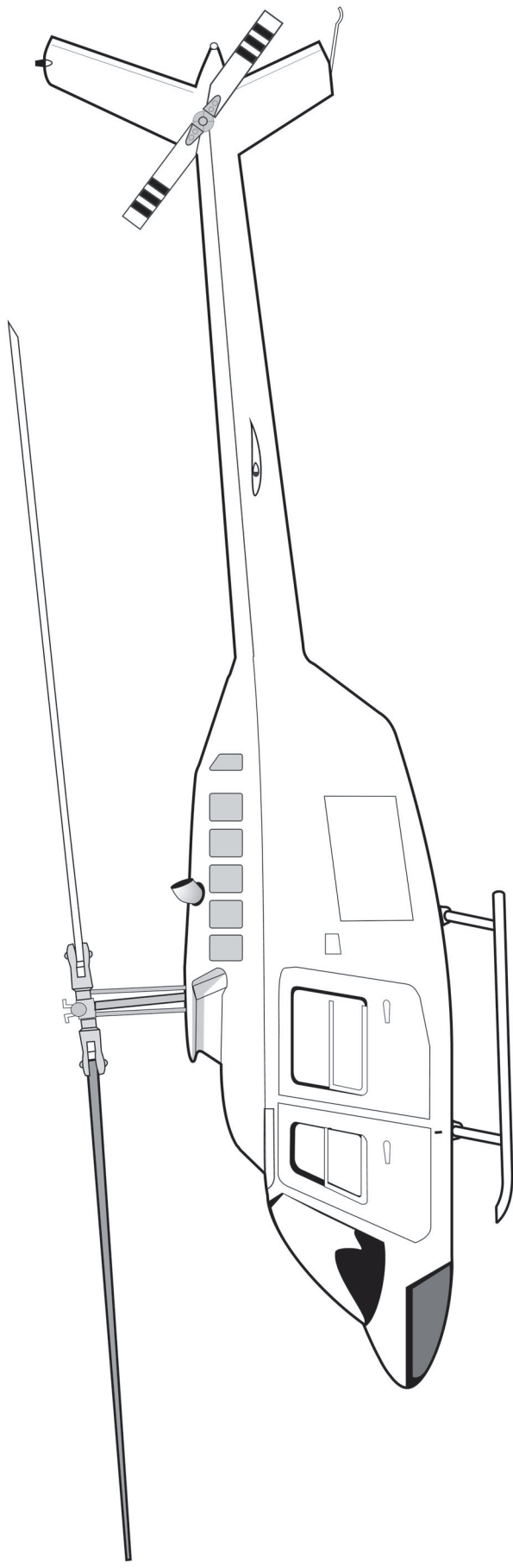

BASE COLOR  
NAME \_\_\_\_\_  
NUMBER \_\_\_\_\_

ACCENT COLOR  
NAME \_\_\_\_\_  
NUMBER \_\_\_\_\_

MAJOR COLOR  
NAME \_\_\_\_\_  
NUMBER \_\_\_\_\_

### **PAIN T SELECTION NOTES:**

**1. COLOR RENDERINGS (ORIGINAL) MUST BE PROVIDED FOR ANY DEVIATION TO THE STANDARD SCHEMES (ALL MODELS).**

**2. CUSTOM PAINT SCHEMES TO CUSTOMER SPECIFICATION ARE AVAILABLE, AND A PRICE QUOTE WILL BE PROVIDED ON REQUEST. PLEASE PROVIDE AS MUCH DETAIL AS POSSIBLE WHEN DESCRIBING SPECIAL INSTRUCTIONS AND CUSTOM PAINT SCHEMES.**

**3. THE DANGER ARROW IS ALWAYS APPLIED ON THE TAIL BOOM BETWEEN THE HORIZONTAL STABILIZER AND THE TAIL ROTOR, NOT WITHSTANDING ANY OTHER ILLUSTRATIONS.**

**4. UNLESS CLEARLY SPECIFIED (LOCATION, DIMENSION, COLOR), REGISTRATION MARKINGS WILL BE APPLIED PER FAA REGULATIONS (ALL MODELS).**

**5. METALLIC PAINT CAN NOT BE APPLIED OVER RADOME AREAS WHEN A RADAR IS INSTALLED.**

**6. PLACEMENT OF BELL MODEL LOGOS IS EFFECTED BY INDIVIDUAL PAINT SCHEMES, AND WILL BE APPLIED AT THE DISCRETION OF BELL HELICOPTER UNLESS OTHERWISE SPECIFIED BY THE CUSTOMER.**



A Textron Company

P.O. Box 482, Fort Worth, Texas 76101,  
Phone: (817) 280-2800, Fax: (817) 278-2800  
[www.bellhelicopter.textron.com](http://www.bellhelicopter.textron.com)

**BELL HELICOPTER TEXTRON  
DIVISION OF TEXTRON CANADA LTD.**  
12,800 rue de l' Avenir Mirabel, Quebec, Canada J7J1R4  
Phone: (450) 437-2729 Fax: (450) 437-2066

The data set forth in this brochure are general in nature and may vary with conditions. For performance data and operating limitations for any specific flight mission reference must be made to the approved flight manual.

Written, Edited and Layout by:  
Dave Wyatt  
817-280-6918  
E-Mail Address: [dwyatt@bellhelicopter.textron.com](mailto:dwyatt@bellhelicopter.textron.com)

© 2004 Bell Helicopter Textron Inc.  
All Rights Reserved.  
Printed in USA  
January 2004